

KORG



CONCERT

KORG DIGITAL PIANO

C-350 **PCI/F**

C-150

OWNER'S MANUAL

Thank you for purchasing the Korg Digital Piano Concert C-350/150. To ensure long, trouble-free operation, please read this manual carefully.

Contents

IMPORTANT SAFETY INSTRUCTIONS	2
Before You Begin	3
Features	3
The Backup Battery	3
Introduction	4
1. Layout	4
2. Preparing to play	8
Plug in the power cable	8
Open the key cover	8
Turn on the power	8
Adjust the volume	8
When using headphones	8
When using the Music Stand	8
3. Listening to the demo songs	9
Playing	10
1. Select the voice	10
2. Selecting Voice Modes	10
3. Add various effects	10
4. Using Pedals	11
5. Using the Built-In Metronome	12
6. Touch Control	13
7. Transpose Function	14
8. Tune Function	15
9. Changing Temperaments	15
Using the Recorder	16
1. Recording	16
2. Playing Back	16
3. Deleting Your Recorded Data	17
4. Reading the Memory Usage Gauge	17
Connections with other devices	18
1. Connecting a synthesizer or audio device	18
2. Connecting MIDI device	18
3. Connections with a computer (C-350 only)	22
Data	24
1. Korg MIDI Driver installation and setup	24
2. Assembling the Stand	30
3. MIDI Implementation Chart	32
4. Trouble Shooting	33
5. Specifications	33
6. Index	34
7. MIDI/TRANSCOPE Switch	35

IMPORTANT SAFETY INSTRUCTIONS

WARNING — When using electric products, basic precautions should always be followed, including the following.

1. Read all the instructions before using the product.
2. Do not use this product near water — for example, near a bathtub, washbowl, kitchen sink, in a wet basement, or near a swimming pool, or the like.
3. This product should be used only with a cart or stand that is recommended by the manufacturer.
4. This product, either alone or in combination with an amplifier and headphones or speakers, may be capable of producing sound levels that could cause permanent hearing loss. Do not operate for a long period of time at high volume level or at a level that is uncomfortable. If you experience any hearing loss or ringing in the ears, you should consult an audiologist.
5. The product should be located so that its location or position does not interfere with its proper ventilation.
6. The product should be located away from heat sources such as radiators, heat registers, or other products that produce heat.
7. The product should be connected to a power supply only of the type described in the operating instructions or as marked on the product.
8. This product may be equipped with a polarized line plug (one blade wider than the other). This is a safety feature. If you are unable to insert the plug into the outlet, contact an electrician to replace your obsolete outlet. Do not defeat the safety purpose of the plug.
9. The power-supply cord of the product should be unplugged from the outlet when left unused for a long period of time.
10. Care should be taken so that objects do not fall and liquids are not spilled onto the enclosure through openings.
11. The product should be serviced by qualified service personnel when:
 - A. The power-supply cord or the plug has been damaged; or
 - B. Objects have fallen, or liquid has been spilled into the product; or
 - C. The product has been exposed to rain; or
 - D. The product does not appear to operate normally or exhibits a marked change in performance; or
 - E. The product has been dropped, or the enclosure damaged.
12. Do not attempt to service the product beyond that described in the user-maintenance instructions. All other servicing should be referred to qualified service personnel.

SAVE THESE INSTRUCTIONS



WARNING:
TO REDUCE THE RISK OF FIRE OR ELECTRIC SHOCK DO NOT
EXPOSE THIS PRODUCT TO RAIN OR MOISTURE.



The lightning flash with arrowhead symbol, within an equilateral triangle, is intended to alert the user to the presence of uninsulated "dangerous voltage" within the product's enclosure that may be of sufficient magnitude to constitute a risk of electric shock.



The exclamation point within an equilateral triangle is intended to alert the user to the presence of important operating and maintenance (servicing) instructions in the literature accompanying the product.

CAUTION

TO PREVENT ELECTRIC SHOCK, MATCH WIDE BLADE OF PLUG TO WIDE SLOT, FULLY INSERT.

ATTENTION - POUR ÉVITER LES CHOCs ÉLECTRIQUES, INTRODUIRE LA LAME LA PLUS LARGE DE LA FICHE DANS LA BORNE CORRESPONDANTE DE LA PRISE ET POUSSER JUSQU' AU FOND.

THE FCC REGULATION WARNING

This equipment has been tested and found to comply with the limits for a Class B digital device, pursuant to Part 15 of the FCC Rules. These limits are designed to provide reasonable protection against harmful interference in a residential installation. This equipment generates, uses, and can radiate radio frequency energy and, if not installed and used in accordance with the instructions, may cause harmful interference to radio communications. However, there is no guarantee that interference will not occur in a particular installation. If this equipment does cause harmful interference to radio or television reception, which can be determined by turning the equipment off and on, the user is encouraged to try to correct the interference by one or more of the following measures:

Reorient or relocate the receiving antenna.
Increase the separation between the equipment and receiver.
Connect the equipment into an outlet on a circuit different from that to which the receiver is connected.
Consult the dealer or an experienced radio/TV technician for help.
Unauthorized changes or modification to this system can void the user's authority to operate this equipment.

CE mark for European Harmonized Standards

CE mark which is attached to our company's products of AC mains operated apparatus until December 31, 1996 means it conforms to EMC Directive (89/336/EEC) and CE mark Directive (93/68/EEC).

And, CE mark which is attached after January 1, 1997 means it conforms to EMC Directive (89/336/EEC), CE mark Directive (93/68/EEC) and Low Voltage Directive (73/23/EEC). Also, CE mark which is attached to our company's products of Battery operated apparatus means it conforms to EMC Directive (89/336/EEC) and CE mark Directive (93/68/EEC).

IMPORTANT NOTICE FOR THE UNITED KINGDOM

As the colours of the wires in the mains lead of this apparatus may not correspond with the coloured markings identifying the terminals in your plug, proceed as follows:

- the wire which is coloured blue must be connected to the terminal which is marked with the letter N or coloured black.
- the wire which is coloured brown must be connected to the terminal which is marked with the letter L or coloured red.
- Do not connect the wire to earth terminal of a three-pin plug.

Before You Begin

Location

To prevent damage to the instrument electronics, do not use or store it for extended periods where it may be exposed to:

- direct sunlight
- extreme temperature or humidity
- sand or dust
- excessive vibration

Power Supply

- Only connect the instrument to electrical outlets matching the specifications on the name plate at the rear of the unit.

Note: If necessary, add the appropriate step-up or step-down transformer. Connecting to the wrong polarity or voltage can irreparably damage the instrument.

- To help prevent noise and poor sound quality, avoid connecting the instrument to the same electrical circuit as motors or large appliances.
- For the same reasons, never overload the electrical circuit with too many extension cords.
- Always start with the volume at a low level and gradually increase it—especially when the instrument is connected to external equipment.

Interference

To minimize the risk of radio-frequency interference:

- Keep the instrument away from fluorescent light fixtures and other sources of radio-frequency noise that may disrupt operation of the instrument's main microprocessor.
- Never use the instrument in the immediate vicinity of a radio, television set, or similar equipment, as the equipment may pick up radio-frequency noise from the microprocessor.
- If operation becomes erratic or unpredictable or the instrument fails to respond, reset the micro-processor by turning off the instrument, waiting a few seconds and then turning it on again.

Rear Connections

Only use jacks and connectors matching the corresponding connectors available at the rear of the instrument.

Handling

- Never apply excessive force to keys, switches, terminals and other components.
- Avoid dropping the instrument.

Treatment of the Stand

If you use the stand for long periods of time, the screws may become loose. For safety, retighten the screws if you notice significant shaking during use or if you move the stand to another place (see "Assembling the stand").

Cleaning

- Wipe the exterior of the instrument with a clean, dry cloth to remove dust and dirt.
- Never use harsh cleanser, organic solvents, or flammable polishes.

Foreign Objects

- Do not place vases or beverage containers on the instrument. Liquid spills may cause fire or electrical shock, as well as cause permanent damage to the instrument.
- Care should be taken so that metal objects such as pins and coins do not fall into the enclosure through openings between keys.

If any of the above has occurred, turn off the power, unplug the power cord from the outlet and contact your dealer or a KORG service center.

Warranty

Have your warranty card validated at the place of purchase and keep it in a safe place until the warranty period expires.

Manual

This manual is your guide to using the instrument properly and effectively. Keep it in a safe place.

Features

Six voices

The piano's "AI² Synthesis System" produces six realistic voices: concert piano, electric piano, harpsichord, vibes, organ, and strings.

Digital effects

Set the reverberation effects to simulate a large concert hall. Add modulation effects to obtain a wider sound.

Voice combinations

Use the LAYER mode to play two different voices at the same time.

Pedal effects

Damper, sostenuto, and soft pedals work in the same way as the corresponding pedals on an acoustic piano.

Only C-350: The damper pedal on the C-350 includes a resonance feature that simulates the resonance effect of an acoustic damper pedal.

Built-in metronome

Use the metronome to set both meter and tempo. Metronome volume is adjustable, and you can select a bell sound for the accented beat.

Recorder

Use the piano's built-in recorder to record and play back your performances.

Touch control

The piano offers three levels of keyboard response. Select the level by pressing the appropriate TOUCH key combination.

Premodern temperaments

In addition to the modern Equal temperament (tuning), your piano also offers the premodern Kirnberger and Werckmeister temperaments. Select either of these temperaments to accurately reproduce the sound of a premodern keyboard instrument.

Transposition and tuning

Use the transposition function to transpose any key into any other. Use the tuning function to make fine adjustments in pitch.

MIDI

Your piano comes equipped with the industry-standard "Musical Instrument Digital Interface." You can use MIDI to connect your piano to computers and other electronic instruments. Your piano can drive and be driven by external devices. The piano's "MIDI Multivoice function" allows external input to drive up to four of the piano's voices at the same time.

The Backup Battery

Your piano's backup battery enables the memory to retain recorder data and various settings even while the piano's power is off. If the [TRANSPOSE/FUNCTION] lamp begins blinking when you switch on the piano, it is time to change the battery. For instructions, refer to your nearest service center or dealer.

To switch the lamp off, press the [TRANSPOSE/FUNCTION] switch.

Introduction

1. Layout

C-350

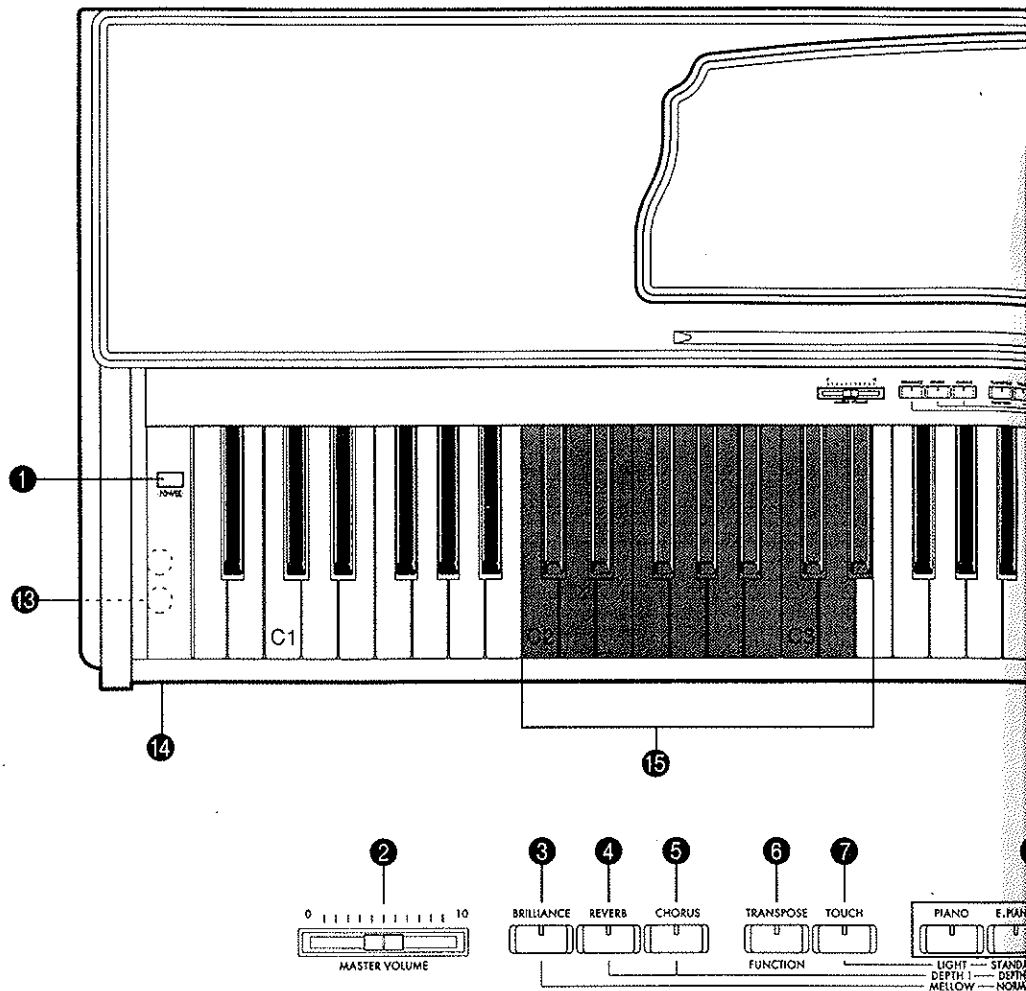

1 [POWER] switch

Use this switch to turn the piano's power on or off.(page 8)

2 [MASTER VOLUME] slider

Move the slider right or left to adjust the volume.(page 8)

3 [BRILLIANCE] switch

Set the "brilliance" of the instrument's sound.(page 10)

4 [REVERB] switch

Adds reverb.(page 11)

5 [CHORUS] switch

Adds a chorus effect.(page 11)

6 [TRANSPOSE/FUNCTION] switch

This is a multipurpose switch: use it to transpose the key (page 14), to implement MIDI settings (page 19), or to make various other settings.(page 34)

7 [TOUCH] switch

Press this switch to select the keyboard response.(page 13)

8 [VOICE SELECTOR] switches

Press one of these switches to select the voice.(page 10)
Use LAYER mode to play two voices at once.(page 10)

9 [TEMPO] control slider

Move this slider to set the tempo for the metronome or for recorder play back.(page 12)

10 [METRONOME] switch

Press this switch to turn the metronome on or off.(page 12)

11 [RECORDER] switches

Use these switches to control recording and playback.
(page 16)

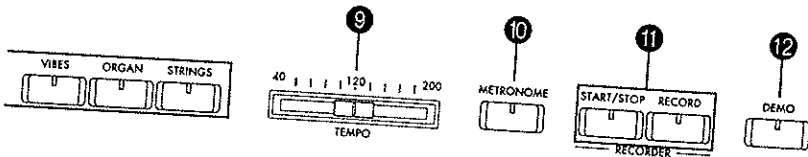
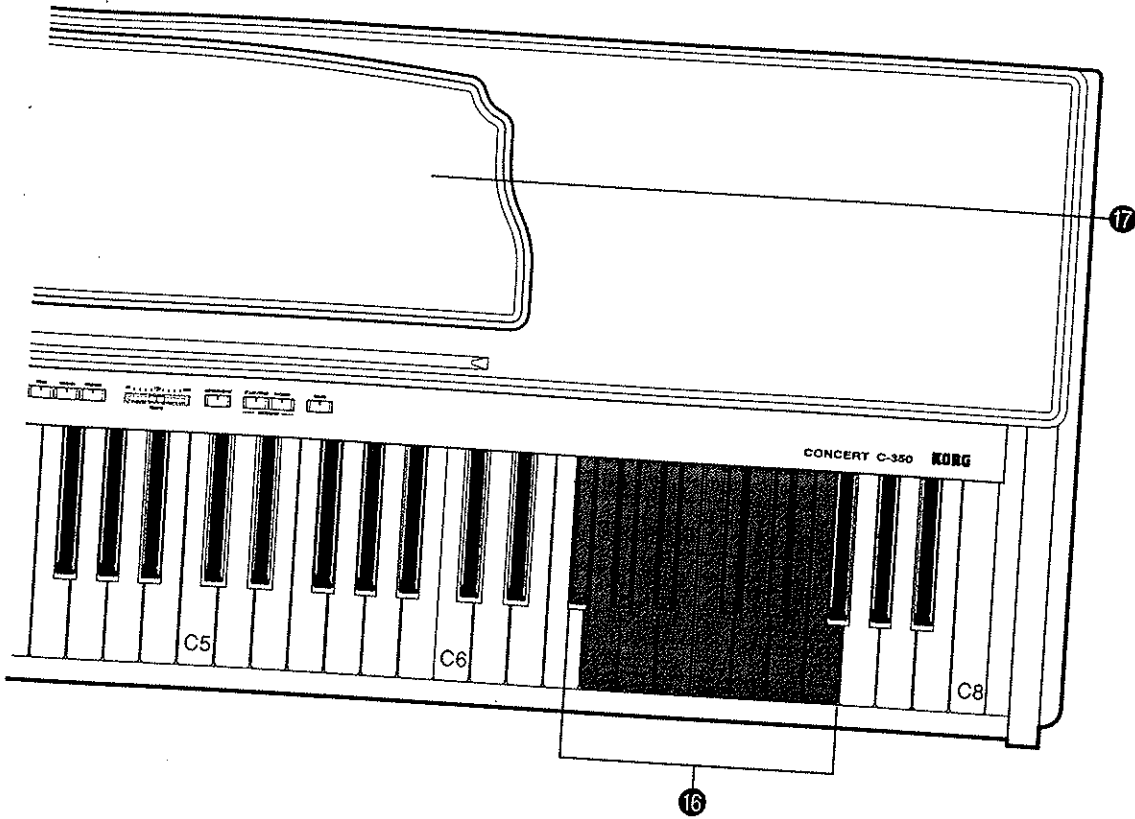

See page 18 for a description of the terminals on the rear panel.

- 12 [DEMO] switch
Press this switch to plays the built-in demo songs. (page 9)
- 13 HEADPHONE jacks (on the underside of the piano)
- 14 POWER indicator
- 15 MIDI-channel selection keys
- 16 Tuning Area
Use these keys to set MIDI channels.
- 17 Music Stand
- 18 Pedals

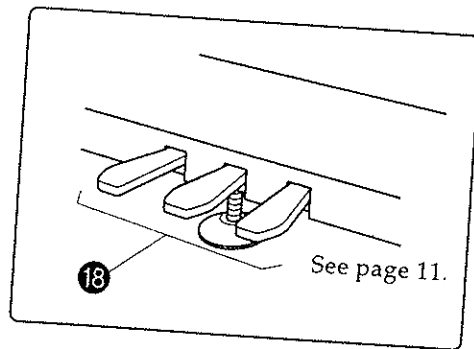

C-150

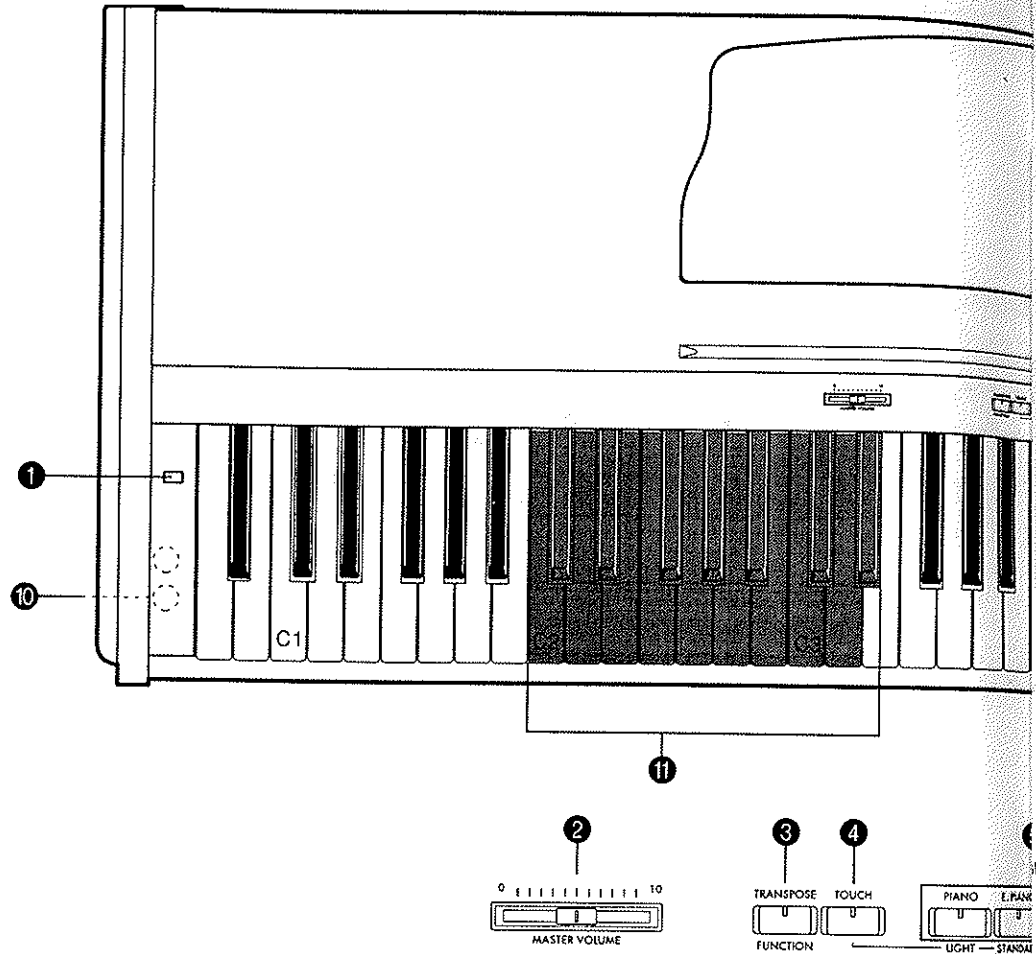

- 1 [POWER] switch**
Use this switch to turn the piano's power on or off.(page 8)
- 2 [MASTER VOLUME] slider**
Move the slider right or left to adjust the volume.(page 8)
- 3 [TRANPOSE/FUNCTION] switch**
This is a multipurpose switch: use it to transpose the key (page 14), to implement MIDI settings (page 19), or to make various other settings.(page 34)
- 4 [TOUCH] switch**
Press this switch to select the keyboard response.(page 13)
- 5 [VOICE SELECTOR] switches**
Press one of these switches to select the voice.(page 10)
Use LAYER mode to play two voices at once.(page 10)
- 6 [TEMPO] control slider**
Move this slider to set the tempo for the metronome or for recorder play back.(page 12)
- 7 [METRONOME] switch**
Press this switch to turn the metronome on or off.(page 11)
- 8 [RECORDER] switches**
Use these switches to control recording and playback.(page 16)
- 9 [DEMO] switch**
Press this switch to plays the built-in demo songs.(page 9)
- 10 HEADPHONE jacks (on the underside of the piano)**
- 11 MIDI-channel selection keys**
Use these keys to set MIDI channels.

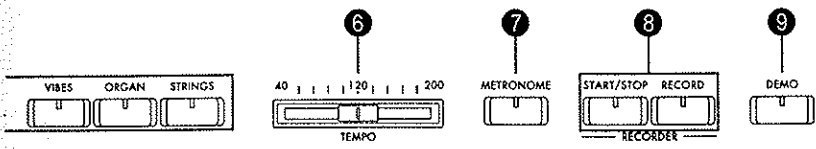
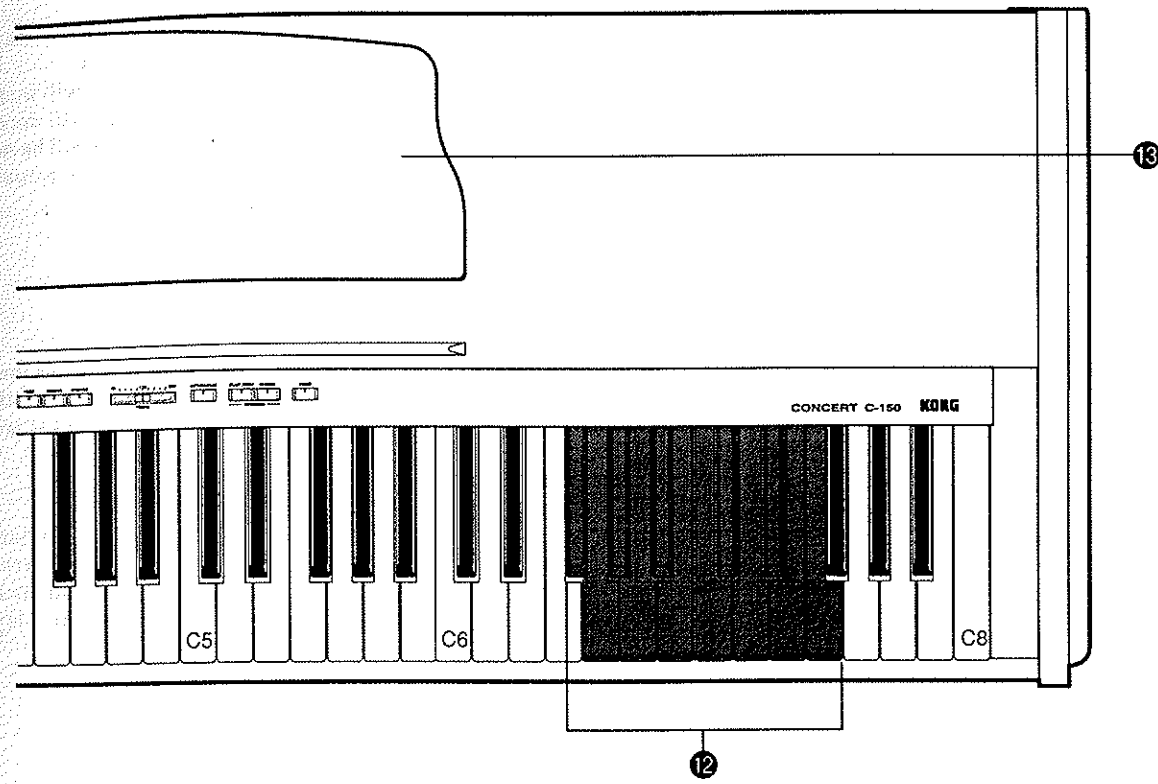

See page 18 for a description of the terminals on the rear panel.

- 12 Tuning Area
- 13 Music Stand
- 14 Pedals

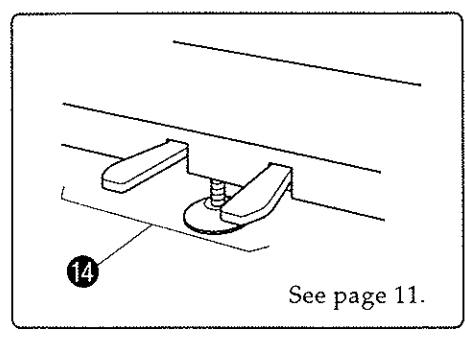

2. Preparing to play

1 Plug in the power cable

Plug the power cable into an AC outlet. Be sure to use an AC outlet of the correct voltage for your instrument.

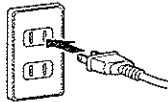

AC Local Voltage

2 Open the key cover (C-350 only)

Lightly lift the center of the edge, and gently slide the cover away from you. To close the key cover, lightly grasp the center of the edge, and slide it toward you.

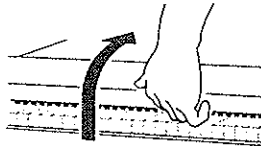

Note: When opening or closing the key cover, be careful not to pinch your fingers.

Note: Applying excessive force, or opening and closing the cover roughly may cause malfunction.

Note: Always check that there is nothing on top of the cover before opening it. Any coins, paper, or other small objects left on the cover may slide into the unit when the cover is opened.

3 Turn on the power

Press the [POWER] switch to turn on the power.

1 When the power is turned on, the POWER indicator located on the left front will light. (C-350 only)

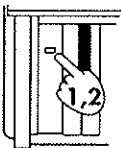

2 To turn the power off, press the [POWER] switch once again.

When the power is off, the POWER indicator located on the left front will be off. (C-350 only)

4 Adjust the volume

Raise the [MASTER VOLUME] slider to approximately the middle position.

Moving the slider toward the right will increase the volume. Moving it toward the left will decrease the volume. With a setting of "0" there will be no sound. Adjust an appropriate volume while actually playing the instrument.

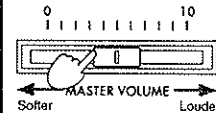

The [MASTER VOLUME] slider controls the volume that is output from the built-in speakers, the headphone jack, and the rear panel OUTPUT jacks.

When using headphones

Insert the headphone's plug into the jack.

You can connect up to two sets of stereo headphones. Headphone connection automatically cuts off the internal speakers, so you can play at any volume without disturbing others.

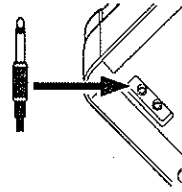

When using the Music Stand

To prop up the music stand, pull out the flaps and fit them into the base, forming a triangle.

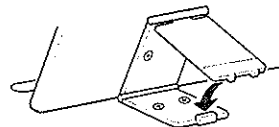

3. Listening to the demo songs

The piano includes 12 built-in demo songs: six in bank A and six in bank B. Listening to these demos will give you a good idea of the expressive possibilities offered by this instrument.

1 Set the piano into DEMO mode.

Press the [DEMO] switch.



The piano enters DEMO mode and bank A is selected. The [VOICE SELECTOR] lamps come on sequentially, then all come on at once, and then the lamp pattern repeats.

If you wish to play a demo from bank A, proceed to Step 3. If you wish to change to bank B, go on to Step 2.

2 Change to bank B.

Press the [DEMO] switch again to switch to bank B.

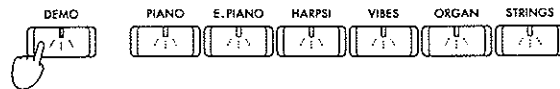

The [VOICE SELECTOR] lamp pattern changes: all the lamps are now blinking. You can now proceed to step 3 to select a demo from bank B.

You can exit from DEMO mode by pressing the [DEMO] switch once again.

Note: You cannot use the voice selectors to change voices while DEMO mode is selected. The metronome function and tempo-adjustment feature are also disabled.

3 Select a demo.

■ Selecting by [VOICE SELECTOR].

To start playback of a specific demo, press the corresponding [VOICE SELECTOR]. (The table below shows the demo assignments for each bank.)

	VOICE	A BANK	B BANK
1	PIANO	F.Chopin/Scherzo No.2 Bb-minor Op.31	L.v.Beethoven/For Elise
2	E.PIANO	KORG Original/The Harp of Wind	F.Mendelssohn/Springs Song Op.62-6
3	HARPSI	J.S.Bach/Italian Concert BWV971	F.Chopin/Valse No.6 Db-major Op.64-1
4	VIBES	N.RIMSKY-Korsakov/The Flight of The Bumble Bee	W.A.Mozart/Sonate K.331
5	ORGAN	F.Mendelssohn/Wedding March	F.Burgmuller/"La chevaleresque" Op.100-25
6	STRING	J.S.Bach/Air on the G string	A.Ellmenreich/Sping Song

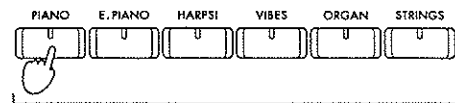

Press one of the selectors to choose a demo.

When the piano reaches the end of the demo, it automatically advances to the next demo in the same bank. Playback then proceeds endlessly, cycling from one demo to the next.

■ Starting by [START/STOP] switch.

To start endless playback of all 12 demos, beginning from the first demo of track A, press the [START/STOP] switch.

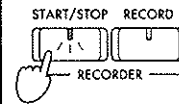

While demo playback is in progress, you can switch to a different demo (within the currently active bank) by pressing the corresponding [VOICE SELECTOR]. If you press the [STRINGS] switch while the piano is playing the first demo in bank A, the piano immediately switches to the sixth demo in bank A. Once you have pressed the selector, playback proceeds endlessly within the same bank only.

4 Stopping the playback.

You can stop playback by pressing the [START/STOP] switch, or by pressing the [VOICE SELECTOR] corresponding to the currently playing song. The bank display returns to its previous state.

5 Exiting from DEMO mode.

To exit the mode while demo playback is in progress, press the [DEMO] switch once.

To exit the mode while demo playback is stopped, press the [DEMO] switch either once (if bank B is currently selected) or twice (if bank A is currently selected).

Playing

1. Select the voice

Press a [VOICE SELECTOR] to choose the voice.

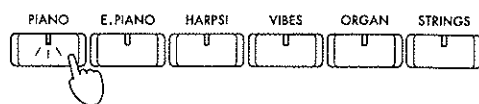

PIANO	Bright acoustic grand piano.
E.PIANO	Synthesized electric piano.
HARPSI	Traditional harpsichord.
VIBES	Jazz vibraphone.
ORGAN	Pipe organ sound.
STRINGS	String section.

Sounds processed with INFINITY™



By using LAYER mode, you can set the piano to play two voices at once. In LAYER mode, the piano plays both voices over the entire range of the keyboard.

2. Selecting Voice Modes

The piano offers two voice modes: SINGLE and LAYER.

- SINGLE** This, the normal performance mode, uses one sound over the entire range of the keyboard.
- LAYER** This mode simultaneously uses two voices over the entire range of the keyboard.

Note: The LED indicators in the switches light to indicate which voice or voices are currently in use.

SINGLE

Press a [VOICE SELECTOR] and every note across the range of the keyboard will sound the selected voice (for example, PIANO).

LAYER

Hold down one [VOICE SELECTOR] and press another and every note over the range of the keyboard will sound both selected voices (for example, PIANO and STRINGS).

Since the LAYER mode uses two voices, a maximum of 16 notes (or 10, if the PIANO voice is selected), instead of the normal 32, can be played at a given time.

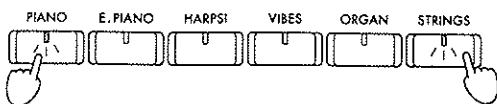

To Cancel the LAYER mode, simply select a different voice.

Adjusting the relative volume

Since the LAYER mode both use two voices, you may wish to adjust the relative loudness of the voice:

- 1 Switch to the LAYER mode, if not already there.
- 2 Hold down the [VOICE SELECTOR] corresponding to the voice that you wish to make softer.
- 3 Make the other voice louder by pressing the corresponding [VOICE SELECTOR] as often as necessary to achieve the desired balance.

Example: When Selecting PIANO and STRINGS.

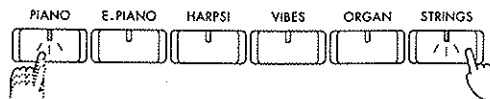

While repeatedly pressing this switch to make this voice louder. Hold down this switch to make this voice softer.

Note: Any changes that you make affect only the current voice. The new volume balance settings remain in effect through all subsequent voice changes until you change them. Even after turning the unit off, the volume balance settings in memory.

3. Add various effects (C-350 only)

Setting the Brilliance

To set the brilliance, hold down the [BRILLIANCE] switch and press [PIANO], [E.PIANO], or [HARPSI] switch.

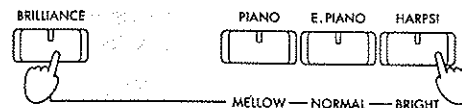

PIANO	MELLOW
E.PIANO	NORMAL
HARPSI	BRIGHT

You can check the current setting simply by holding down the [BRILLIANCE] switch. The lamp corresponding to the current setting (the lamp on the [PIANO], [E.PIANO] or [HARPSI] switch) lights up while the switch is held down.

Adding a Reverb Effect

The reverb effect produces the echoing acoustics characteristic of a large room or concert hall. The C-350 offers you three different reverb depths.

To set the reverb effect for the selected voice, hold down the [REVERB] switch and press [PIANO], [E. PIANO], or [HARPSI] switch.

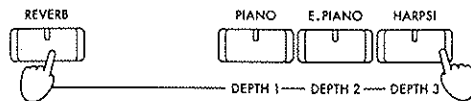

DEPTH1	produces light reverb.
DEPTH2	produces moderate reverb.
DEPTH3	produces deep reverb.

You can check the current setting by holding down the [REVERB] switch. The lamp corresponding to the current reverb setting (the lamp on the [PIANO], [E. PIANO] or [HARPSI] switch) lights up while the switch is held down.

To turn reverb off, press the [REVERB] switch so that the lamp on the switch goes off.

Adding a Chorus Effect

The chorus effect adds thickness and undulation to the sound.

To set the chorus effect for the selected voice, hold down the [CHORUS] switch and press [PIANO], [E. PIANO], or [HARPSI] switch.

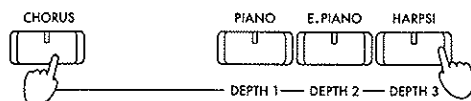

DEPTH1	produces a light chorus effect.
DEPTH2	produces a moderate chorus effect.
DEPTH3	produces a deep chorus effect.

You can check the current setting by holding down the [CHORUS] switch. The selector lamp corresponding to the current chorus setting (the lamp on the [PIANO], [E. PIANO] or [HARPSI] switch) lights up while the switch is held down.

To turn the chorus effect off, press the [CHORUS] switch so that the lamp on the switch goes off.

Note: You can set BRILLIANCE, REVERB, and CHORUS effects separately for each voice. The piano memorizes the settings, and automatically restores them each time you select the voice.

Note: The piano retains all of these settings (the brilliance setting, the reverb and chorus ON/OFF settings, and the reverb and chorus depth settings) for each voice even while power is off.

4. Using Pedals

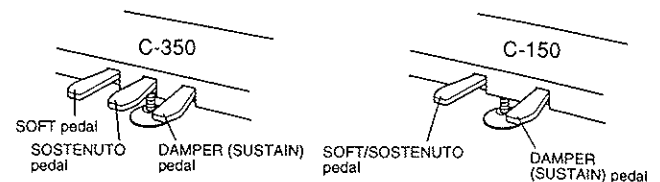

The left pedal on the C-150 can function as either a soft pedal or a sostenuto pedal.

DAMPER

This pedal simulates the effect of a damper pedal on an acoustic piano. When the pedal is depressed on an acoustic piano, small felts, called dampers, are lifted from the strings. This allows all strings to vibrate, whether the key for those strings has been struck or not. When the pedal is released, strings vibrating without keys depressed are damped.

(C-350 only)

If the Surround parameter is set to "Off", pressing the damper pedal produces an effect that simulates the sound of an acoustic piano's resonating strings, when the PIANO voice is selected.

SOFT

This pedal simulates the effect of a soft pedal on an acoustic piano. When the pedal is depressed on an acoustic piano, the sound produced is softer, as the hammers strike one fewer string per key.

SOSTENUTO

This pedal simulates the effect of a sostenuto pedal on an acoustic piano. When this pedal is depressed on an acoustic piano, dampers for keys depressed when the pedal is depressed are suspended above the strings until the pedal is released. This allows certain strings to vibrate freely while other strings are struck and damped by depressing and releasing keys.

■ Selecting the Function of the Left Pedal (C-150 only)

To change the pedal's function, hold down the [TRANPOSE/FUNCTION] switch and step down on the pedal.

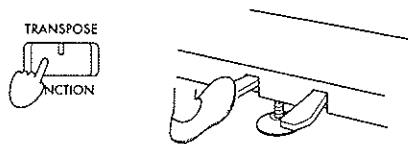

The function switches between "soft" and "sostenuto" each time you do this.

Note: no special indication is provided to show the pedal's current function. If necessary, try switching the function back and forth and comparing the difference in the sound produced by using the pedal.

Note: This setting remains in memory even after the power has been switched off.

■ Using the Pedals with LAYER Mode

In the LAYER mode, the pedals may be used with just one voice or with both. To change between three possible pedal settings:

1 Hold down the [TRANPOSE/FUNCTION] switch.

Press the damper pedal.

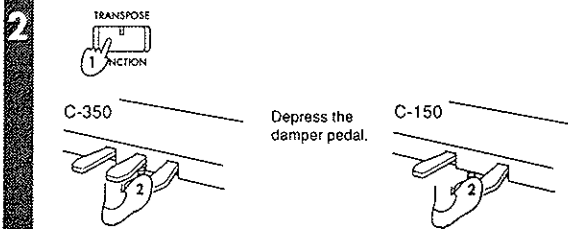

Note: The changes will cycle with each press of the pedal. (See illustration.)

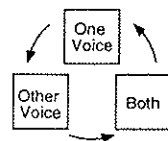

Note: The LED indicators in the [VOICE selector] switches light to indicate the voice or voices that use the pedals.

Note: The individual pedal settings for the LAYER mode remain in effect through all subsequent mode changes until you turn off the instrument. When the instrument is turned on, the pedals always start with the BOTH setting for the LAYER mode.

5. Using the Built-In Metronome

The instrument has a built-in metronome. It is capable of accenting particular beats, or groups of beats. This feature allows the metronome to keep time in different meters.

Note: The metronome sounds through the built-in speakers and headphones.

■ METRONOME

Pressing this switch alternately starts and stops the metronome.

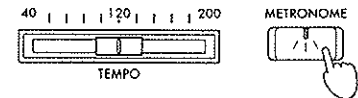

■ Adjusting the relative volume

1 Press and release the [METRONOME] switch to start the metronome.

2 To make the metronome louder, hold down the [METRONOME] switch and press the [RECORD] switch repeatedly.

To make the metronome softer, hold down the [METRONOME] switch and press the [START/STOP] switch repeatedly.

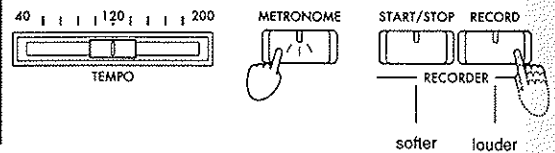

■ TEMPO

Use the [TEMPO] control slider to adjust the tempo.

The available range is ♩=40~200.

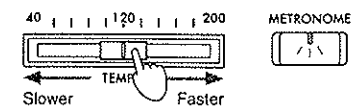

Note: The [TEMPO] control slider also adjusts the RE-CORDER tempo.

Pattern Selector Switches

With the metronome running, hold down the [METRONOME] switch and press the [VOICE SELECTOR] corresponding to the desired meter.

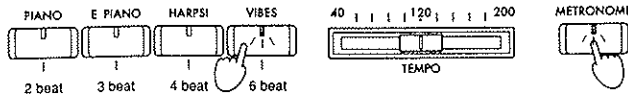

When you press a selector, its lights up, and the metronome being accenting the first beat of each measure.

Canceling the meter

To cancel the meter accentuation, hold down the [METRONOME] switch and press the lighted [VOICE SELECTOR]. The metronome switches to an unaccented beat.

Note: When the piano is turned on, the metronome is set to the unaccented beat pattern.

Selecting the accent sound

You can select whether or not to use a bell sound for the accented beat. To make the setting, switch the metronome on, then hold down [METRONOME] switch and press the [STRINGS] switch to turn the bell on, or the [ORGAN] switch to turn it off.

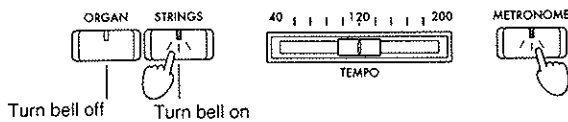

6. Touch Control

The instrument allows for the selection of a variety of touch responses that range from LIGHT to HEAVY.

Setting the keyboard response

To select the touch, hold down the [TOUCH] switch and press [PIANO], [E. PIANO], or [HARPSI] switch.

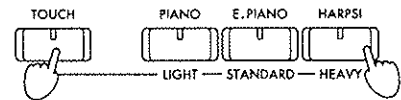

Note: The lamp on the [TOUCH] switch comes on if the touch is set to LIGHT or HEAVY, and goes off if the touch is set to STANDARD.

Note: Whenever the power is turned on, STANDARD is automatically selected.

<p>E.PIANO —STANDARD</p>	<p>Response is similar to acoustic piano. While holding down the [TOUCH] switch, [E.PIANO] lamp on.</p>
<p>PIANO—LIGHT</p>	<p>Light action — normal striking force produces strong sound. While holding down the [TOUCH] switch, [PIANO] lamp on.</p>
<p>HARPSI—HEAVY</p>	<p>Heavy action — normal striking force produces weak sound. While holding down the [TOUCH] switch, [E.PIANO] lamp on.</p>

Playing

7. Transpose Function

The TRANSPOSE function changes the general key of the instrument, shifting the pitch up or down in semitones. The range of transposition is up a perfect fourth (5 semitones) and down a tri-tone (6 semitones). This function eliminates the need to change fingering when changing keys—making it easy to transpose to match a vocalist's range.

■ To transpose the keyboard

- 1** Hold down the [TRANSPOSE/FUNCTION] switch.
- 2** Press a key between F#6 and F7 to select the interval of transposition.

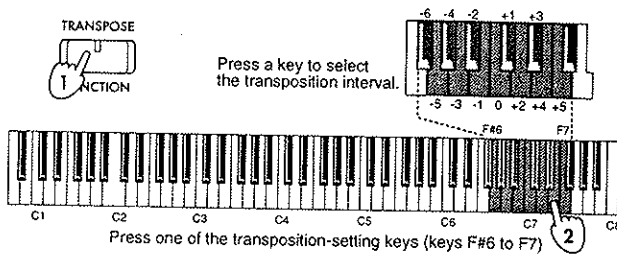

F7 key	Transpose up five semitones. Key C7 produces the note normally associated with Key F7.
C7	No transposition
F#6	Transpose down six semitones. Key C7 produces the note normally associated with Key F#6.

Note: The difference between the selected key and C7 becomes the new interval of transposition. Selecting a key below C7 transposes the key downward. Selecting a key above C7 transposes the key upward.

Note: The LED indicator in the [TRANSPOSE/FUNCTION] switch remains lit while the keyboard is in any key other than the original.

Example: Transposing up one half-step

While holding down the [TRANSPOSE/FUNCTION] switch, press C#7. This transposes the pitch of the instrument so that a piece played in the key of C will sound as if it is played in C#.

Example: Transposing down one whole-step

While holding down the [TRANSPOSE/FUNCTION] switch, press A#6. This transposes the pitch of the instrument so that a piece played in the key of G will sound as if it is played in F.

■ Canceling

To cancel the transposition and restore the original key (C), while holding down the [TRANSPOSE/FUNCTION] switch, press C7.

Note: The transposition setting is automatically lost when you switch the power off.

8. Tune Function

The TUNE function, which uses much smaller increments of pitch, called cents, provides the ability to fine-tune the instrument to another instrument. The range is 50 cents on either side of the standard pitch.

■ To raise the pitch

Hold down [TOUCH] switch and press [RECORD] switch as many times as necessary.

Each press raises the pitch by about 1 cent.

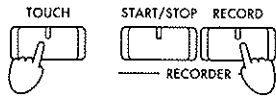

■ To lower the pitch

Hold down [TOUCH] switch and press [START/STOP] switch as many times as necessary.

Each press drops the pitch by about 1 cent.

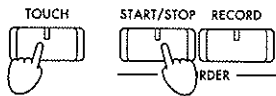

Note: One step is approximately 1 cent. The value can be changed over a range of ± 50 cents. (1 cent is 1/100 of a semitone.)

■ To return to original tuning

Hold down [TOUCH] switch and press [RECORD] switch and [START/STOP] switch at the same time to return to the normal tuning (A4=440Hz).

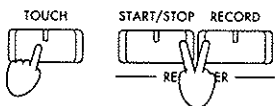

Note: The tuning remains in memory even after the power has been switched off.

9. Changing Temperaments

In recent history, musical instruments have used a tuning system, or temperament, that divides an octave (for example, C4 to C5) into 12 equal steps, called half-steps or semitones. Before the 19th century, however, musical instruments made use of many different temperaments that were based on scales with different sized semitones.

The C-350/C-150 voices can be assigned to an alternate temperament for realistic performance of early music. The two alternate temperaments are:

- Kirnberger
- Werckmeister

■ Selecting the temperament

Hold down [TOUCH] switch and press either [ORGAN] or [STRINGS] switch.

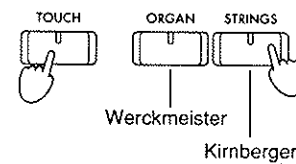

ORGAN	Werckmeister	While holding down the [TOUCH] switch, [ORGAN] lamp on.
STRINGS	Kirnberger	While holding down the [TOUCH] switch, [STRINGS] lamp on.

To return to equal temperament, hold down [TOUCH] switch and press the same [voice selector] again (either [ORGAN] or [STRINGS]) so that the lamp on the selector goes off.

Note: The temperament setting remains in effect through all subsequent use of the instrument until you change it or turn it off. When the power is turned on, the instrument begins with the Equal Temperament setting.

Note: To obtain a more realistic piano sound, equal temperament in the PIANO voice is not exactly equal — the lower ranges are slightly lowered in pitch, and the higher ranges slightly raised. The effect approximates the "stretch tuning" technique used on acoustic pianos.

Using the Recorder

1. Recording

1 Press a [VOICE SELECTOR] to select a voice.

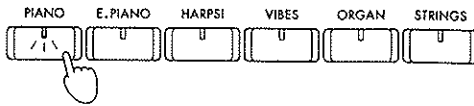

2 Press the [RECORD] switch.
The lamp on the [RECORD] switch comes on, and recording standby.

The RECORD lamp comes on.

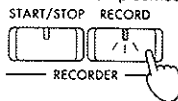

3 To begin recording, do any of the following: (a) press [START/STOP] switch, (b) strike a note on the keyboard, or (c) press down on a pedal.

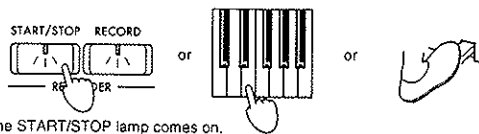

The START/STOP lamp comes on.

If you begin by pressing [START/STOP] switch, the piano counts out a two-bar lead-in before starting actual recording. If you begin by pressing a pedal or key, recording starts immediately.

While recording is in progress, the [START/STOP] lamp remains on.

Note: The piano records any voice changes that you make while recording is in progress. Note, however, that the piano does not store the initial voice used for the recording (the voice you selected at Step 1 above). Before playing the recording back, you should select this voice manually.

4 To stop recording, press the [START/STOP] switch.

To pause at the present position, press the [START/STOP] switch briefly. The recording pauses and the [START/STOP] lamp begins to blink.

To return the recorder to its start position, hold the [START/STOP] switch for longer than one second. The recorder returns and the [START/STOP] lamp goes out.

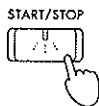

Press the switch briefly: the recorder pauses at its current position, and the [START/STOP] lamp begins blinking.



Hold the switch down: the recorder returns to its start position, and the [START/STOP] lamp goes out.

Note: the piano can record data for one song. If you begin recording again from the beginning, the new data will overwrite the existing data.

Restarting playback from the beginning

To stop the replay and start over from the beginning, depress [START/STOP] switch for longer than one second to return the recorder to its start position. Then repeat the recording procedure starting from step 1 on the previous page.

Continuing from where you left off

If you paused the recorder (as described in step 4 above), you can resume by pressing the [RECORD] switch and then the [START/STOP] switch. If you returned the recorder to its start position, play back your recording to its end, press [RECORD] switch, then [START/STOP] switch.

Note: Any voice changes made in the newly recorded material will be ignored when the material is played back. The voice selection made in the original or first recording of the song will be in effect for playback of the entire song, including the appended material.

Note: Using the [START/STOP] switch to stop in the middle of playback and switch to recording will sometimes cause the newly recorded material to begin at a slightly different place from where playback was stopped.

Note: When cueing a track for re-recording, the data for the remainder of the track will be lost. The remainder of the track, to the end, must be re-recorded.

What the [START/STOP] lamp means...

Lamp is ON	Recording or playback is in progress.
Lamp is BLINKING	Recorder is paused at the middle or end of a recording.
Lamp is OFF	Recording is at the start position.

2. Playing Back

Playback

1 Check the recorder position

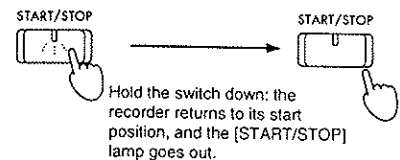

Hold the switch down: the recorder returns to its start position, and the [START/STOP] lamp goes out.

If the [START/STOP] lamp is blinking, the recorder is paused at the middle or end of the recording. If you want to start playback from the beginning, hold down the [START/STOP] switch for at least one second (until the lamp goes out).

- 2** Press the [START/STOP] switch to start the playback.

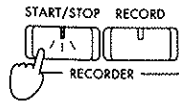

Note: The LED indicator inside the [START/STOP] switch lights to indicate that the recorder is playing back.

- Use the [TEMPO] slider to adjust the speed of playback; left for slower, right for faster. Tempo adjustment does not affect the pitch.

- 3** Press the [START/STOP] switch to stop the playback.

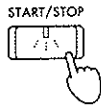

Press the switch briefly: the recorder pauses at its current position, and the [START/STOP] lamp begins blinking.

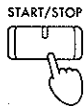

Hold the switch down: the recorder returns to its start position, and the [START/STOP] lamp goes out.

Note: When all the recorded data has been played, the [START/STOP] lamp starts blinking.

Repeating Playback

This feature lets you set the piano so that it plays your recorded song over and over again, in an endless loop.

To start repeated playback, simply press the [TRANPOSE/FUNCTION] switch while playback is in progress, so that the switch's lamp begins blinking.

To stop the playback (and cancel repetitive-playback mode), press [START/STOP] switch.

3. Deleting Your Recorded Data

- 1** While playback of the recording is in progress, hold down the [TRANPOSE/FUNCTION] switch and press the [START/STOP] switch. The lamps on these two switches begins blinking, indicating that piano is standing by to delete the data.

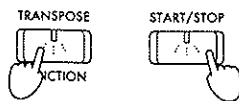

If you decide that you really do not want to delete the data, press the [TRANPOSE/FUNCTION] switch again to cancel the deletion.

- 2** To complete the deletion, press [START/STOP] switch.

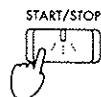

4. Reading the Memory Usage Gauge

Hold down both the [RECORD] switch and the [TRANPOSE/FUNCTION] switch.

The [VOICE SELECTOR] lamps act as a bar graph, lighting up to indicate the amount of data that you have recorded. The number of unlit lamps indicates the amount of recording space remaining.

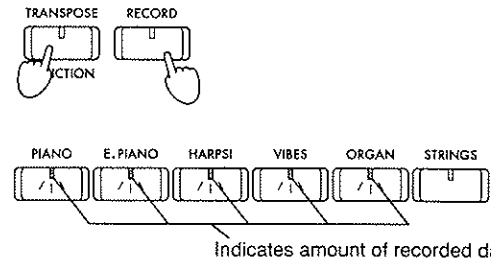

Note: The [RECORD] lamp begins blinking when remaining memory falls below 10% of the total recording memory when there is space for less than 400 additional notes or when the number of recorded measures is 990 (since maximum recordable length is 999 measures). You can retain your recorded data by saving it to a data filer. (See page 21.)

Connections with other devices

1. Connecting a synthesizer or audio device

INPUT (L/MONO, R):

These jacks are for connecting audio signals from synthesizers, drum machines, and other equipment to the instrument's built-in speakers.

Note: Adjust the volume of the connected instrument from that instrument's controls.

OUTPUT (L/MONO, R):

These jacks are for connecting the instrument to the AUX (or LINE) IN jacks on mixers, tape recorders, or home audio systems for routing output to a different speaker system, for example.

Note: The VOLUME slider on the front panel controls the output level.

MIDI (IN/OUT):

These DIN connectors accept optional MIDI cables for connecting the instrument to synthesizers, sequencers, and other MIDI devices. In addition, the connectors are for exchanging performance and other types of data.

PC (TO HOST) (C-350 only):

Used to connect the piano to a PC. See page 22 for more information.

PC/MIDI switch (C-350 only):

Selects use of either the MIDI connectors or the PC (TO HOST) connector.

Note: Never change the PC/MIDI setting while power is ON. Always switch off power before changing the setting.

Note: Never try to use the PC (TO HOST) connector and the MIDI connectors at the same time. If the switch is set to PC, use PC (TO HOST) only; if it is set to MIDI, then use MIDI connectors only. Using the incorrect connector may cause the connected device to malfunction.

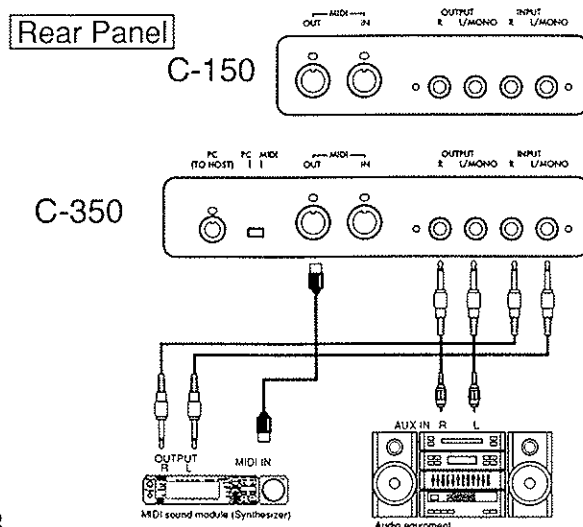

2. Connecting MIDI device

■ What is MIDI

MIDI, or the "Musical Instrument Digital Interface," is the internationally recognized standard for connecting and passing data among electronic musical instruments, computers, and other electronic equipment.

■ What can MIDI do?

MIDI enables you to drive other instruments from the C-350/C-150, to drive the C-350/C-150 from other instruments or devices, and to store performance data to external media. Using MIDI, you can play the C-350/C-150 and have all your keyboard action, pedal action. And voice selections reproduced on an external instrument. Or you can go the other way, using an external MIDI keyboard or sequencer to control the C-350/C-150. You can copy data from the C-350/C-150 recorder to an external data filer, and recall the data later when you want to replay it. And there are various other functions available to you as well.

■ Connection

Connection is made by special MIDI cables. These cables connect into the MIDI terminals provided on all MIDI devices. There are two terminal types, as described below. The terminals on the C-350/C-150 are located on the rear panel.

Note: (C-350 only) Be sure to use MIDI cables when using the MIDI feature (when the PC/MIDI switch is set to MIDI).

Note: (C-350 only) Remember that you should switch the power off before changing the PC/MIDI switch to the MIDI side. Set the switch, then turn the power back on.

MIDI IN

Receives MIDI data from an external keyboard, sequencer, or other MIDI device. The received data drives the C-350/C-150, causing it to produce sound. A MIDI cable runs from this terminal to the MIDI OUT terminal on the external device.

MIDI OUT

Transmits MIDI data to an external device. A MIDI cable runs from this terminal to the MIDI IN terminal on the external device. Use this terminal when you want your playing on the C-350/C-150 keyboard to drive the sound of an external keyboard, or when you want to record it into a sequencer or other computerized device.

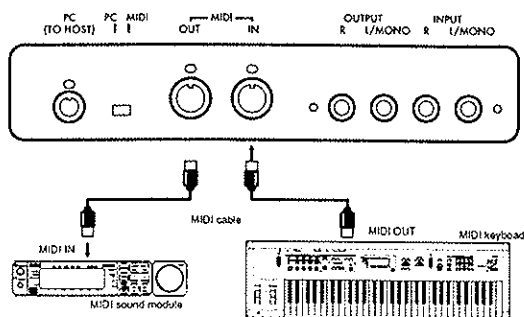

MIDI Default Values

When the power is turned on, the instrument defaults to the following MIDI settings.

MIDI transmission channel	1
MIDI receiving channel	1
LOCAL	ON
PROGRAM CHANGE	ON
CONTROL CHANGE	ON

Changing the MIDI Transmit Channel

The MIDI standard provides 16 separate channels for the transmission of performance data. MIDI master keyboards (controllers) can therefore control up to 16 individual slaves (or groups of slaves acting in unison) by sending channel messages. Performance data messages always include a channel number. Each device on the network reads all messages, but only responds to messages that match the connected instrument's MIDI receive channel.

Selecting a MIDI channel

To change the MIDI transmit channel, hold down the [TRANSCOPE/FUNCTION] switch and press the appropriate key between C2 and D#3.

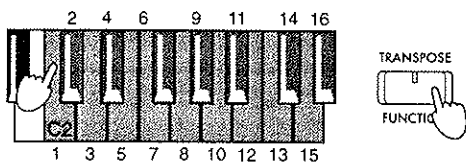

Note: When the power is turned on, the instrument is set up to transmit on channel 1.

Changing the LOCAL ON/OFF Setting

The LOCAL ON/OFF setting allows you to use the instrument as a "silent" MIDI controller. When LOCAL is set to OFF, the instrument's internal voices will not sound—only the sounds of the connected MIDI devices will be heard.

Note: When the power is turned on, the instrument defaults to LOCAL Mode ON.

Switching LOCAL on or off

To change the setting, hold down the [TRANSCOPE/FUNCTION] switch and press the [PIANO] switch.

PIANO lamp off	LOCAL ON
PIANO lamp on	LOCAL OFF

Sending PROGRAM CHANGE Requests

A PROGRAM CHANGE request is a channel message that asks devices on that channel to change the sound that they are playing.

Note: The definition of "program" varies widely between MIDI devices. To verify terminology, consult the manual for the device being controlled.

Using [VOICE SELECTOR]

When the [VOICE SELECTOR] is used to select the voices for the Single and Layer modes, MIDI Program Numbers 0 to 20 are transmitted using the format shown in the table on page .

Note: The above procedure always transmits a PROGRAM CHANGE request, regardless of the PROGRAM CHANGE CANCEL setting. (See "Inhibiting PROGRAM CHANGE Requests" below.)

Inhibiting PROGRAM CHANGE Requests

When the PROGRAM CHANGE function is set to OFF, all incoming and outgoing PROGRAM CHANGE messages are ignored.

Note: This function does not affect selection of internal voices from the front panel [VOICE SELECTOR] switches.

To change the setting, hold down the TRANSCOPE/FUNCTION switch and press the E.PIANO switch.

E.PIANO lamp off	PROGRAM CHANGE ON
E.PIANO lamp on	PROGRAM CHANGE OFF

Note: You can disable the Program Change function independently for each MIDI channel (channels 1 to 16). The piano remembers the setting for each channel (so long as power remains on), and reinvokes the setting each time you come back to that channel.

Note: When the power is turned on, the C-350/C-150 always starts with the PROGRAM CHANGE function ON.

Receipt of program change request

When the piano receives a program change request from an external device, it changes the voice setting as indicated below.

PC#: Program change number

Voice Mode	PC#	Voice
SINGLE	0	PIANO
	1	E.PIANO
	2	HARPSI
	3	VIBES
	4	ORGAN
	5	STRINGS
LAYER	6	PIANO+E.PIANO
	7	PIANO+HARPSI
	8	PIANO+VIBES
	9	PIANO+ORGAN
	10	PIANO+STRINGS
	11	E.PIANO+HARPSI
	12	E.PIANO+VIBES
	13	E.PIANO+ORGAN
	14	E.PIANO+STRINGS
	15	HARPSI+VIBES
	16	HARPSI+ORGAN
	17	HARPSI+STRINGS
	18	VIBES+ORGAN
	19	VIBES+STRINGS
	20	ORGAN+STRINGS

Note: Program change numbers 21 to 127 are ignored.

Inhibiting CONTROL CHANGE Requests

When the CONTROL CHANGE function is set to OFF, all incoming and outgoing CONTROL CHANGE messages are ignored, including those generated by the pedals.

Enabling and disabling control changes

To switch the function on or off, hold down the [TRANPOSE/FUNCTION] switch and press the [HARPSI] switch.

HARPSI lamp off	CONTROL CHANGE ON
HARPSI lamp on	CONTROL CHANGE OFF

When the power is turned on, the instrument always begins with the CONTROL CHANGE function ON.

Note: You can disable the Control Change function independently for each MIDI channel (channels 1 to 16). The piano remembers the setting for each channel (so long as power remains on), and reinvokes the setting each time you come back to that channel.

Note: Do not press down the pedal when switching this function ON and OFF.

Note: External control changes are effective for both voices in the LAYER mode regardless of the individual internal pedal settings. (Refer to the section "Using the Pedals with LAYER Mode".)

MIDI Multivoice Function

The C-350/C-150 can receive data from up to four MIDI channels at once: the MIDI channel you have selected, plus the next three channels in succession. This means that you can use an external sequencer to drive up to four of the piano's voices at the same time.

When you are using this multivoice function, the selected channel drives the selected voice (the voice selected by the [VOICE SELECTOR]), while the next three channels drive the PIANO, E.PIANO, and HARPSI voices, respectively. If you have set the MIDI channel to 1, for example, the data coming in on channel 1 drives the selected voice, while channel 2 drives the PIANO voice, channel 3 the E.PIANO voice, and channel 4 the HARPSI voice. The following table shows the voice/channel correspondence for all MIDI channel settings.

C-350/C-150 MIDI channel	1	2	3	4	5	6	7	8	9	10	11	12	13	14	15	16
Voice selected by VOICE SELECTOR	1	2	3	4	5	6	7	8	9	10	11	12	13	14	15	16
PIANO	2	3	4	5	6	7	8	9	10	11	12	13	14	15	16	x
E.PIANO	3	4	5	6	7	8	9	10	11	12	13	14	15	16	x	x
HARPSI	4	5	6	7	8	9	10	11	12	13	14	15	16	x	x	x

If the C-350/C-150 receives a program change request during multivoice operation, the selected voice changes accordingly. (See page 19.)

Synchronizing with External MIDI devices

The built-in recorder of the instrument is capable of synchronizing with a drum machine, sequencer or other external MIDI devices. To use the C-350/C-150 as the master keyboard (controlling device) and the external device as the slave (controlled device), connect the MIDI OUT jack on the piano to the MIDI IN jack on the external device with a MIDI cable. (To change the MIDI clock setting on external devices, refer to the manual for each device.)

Note: To start and stop the synchronized play with external devices, use the [START/STOP] switch on the C-350/C-150.

Note: The MIDI clock (timing data) sent from the C-350/C-150 will follow changes made with the [TEMPO] control slider.

■ Using the MIDI Data Dump Function

The MIDI DATA DUMP function is used to copy data from the built-in recorder to a MIDI data filer, a device used for storing MIDI data.

Note: The term "MIDI data filer" applies to both hardware and software devices.

A common data filer application is backing up data — in other words, copying the current recorder data to the filer so that you can always get the original data back after editing or deleting the data in the recorder. For further details, consult the manual included with your data filer.

Note: The piano keyboard and panel will remain inoperative until the transmission is complete.

Note: Changes made in the pedal settings cannot be stored in the data filer. (Refer to the section, "Using the Pedals with LAYER Mode".)

Saving Data to the Data Filer

1 Connect the MIDI OUT jack on the piano to the MIDI IN jack on the external device with a MIDI cable.

2 Set the data filer to receive data.

Note: Consult the manual included with the data filer for the necessary procedures.

3 Hold down the [TRANSCOPE/FUNCTION] switch and press the [STRINGS] switch to start transmission.

The [TRANSCOPE/FUNCTION] and [STRINGS] lamps begin blinking, indicating that the piano is ready to transmit.

4 Press [START/STOP] switch to begin transmission.

The [START/STOP] lamp blinks to indicate that transmission is in progress. When the data dump is finished, the lamp goes off and the piano returns to normal operating mode.

Loading Data from the Data Filer

1 Connect the MIDI OUT jack on the external device to the MIDI IN jack on the piano with a MIDI cable.

2 Turn on the power of both units.

The [TRANSCOPE/FUNCTION] and [STRINGS] lamps begin blinking, indicating that the piano is ready to receive.

3 Set up the data filer to transmit the previously-stored piano data.

Note: As there is considerable variation between data filers, consult the manual included with the data filer for additional procedures.

4 Wait for the data filer to indicate the end of the transmission. (Never interrupt either the piano or the data filer while they are working, since such interruptions can cause errors in data transmission.)

Set the data filer to transmit the stored piano data. Consult the data filer's operation manual for instructions.

The piano's [RECORD] lamp blinks to indicate that data reception is in progress. When reception is finished, the lamp goes off and the piano returns to normal operating mode.

3. Connections with a computer (C-350 only)

A special PC I/F connection cable can be used to connect the C-350 to a computer. This allows the computer to play the C-350, or keyboard playing on the C-350 to be recorded on the computer-the same operations can be done using MIDI as discussed on the previous pages.

The C-350 supports direct connection to IBM-PC compatibles and Apple Macintosh machines. Connection is made through a dedicated interface cable running from the PC (TO HOST) connector. To enable this feature, you must set the PC/MIDI switch (located on the piano's rear panel) to the PC side.

Note: Never change the PC/MIDI switch setting while power is ON. Always turn off the power before changing the setting.

Note: Never try to use the PC (TO HOST) connector and the MIDI connectors at the same time. If the switch is set to PC, use PC (TO HOST) only; if it is set to MIDI, then use MIDI connectors only. Using the incorrect connector may cause the connected device to malfunction.

Note: Be sure to use the appropriate PC interface cable when using direct PC communication (when the PC/MIDI switch is set to MIDI).

IBM PC (compatibles):

Connection kit AG-001B (connection cable, "Korg MIDI Driver" software) *sold separately

However, applications which are not Windows compatible cannot be used with this method of connection unless they specifically support the C-350.

Apple Macintosh series:

Connection kit AG-002B (connection cable, "Korg MIDI Driver" software) *sold separately

PC (TO HOST) connector
This connector allows the C-350 to be controlled from the computer, and MIDI message to be transmitted to the computer. Use a PC I/F cable appropriate for your computer to connect the PC (TO HOST) of the C-350 to your computer.

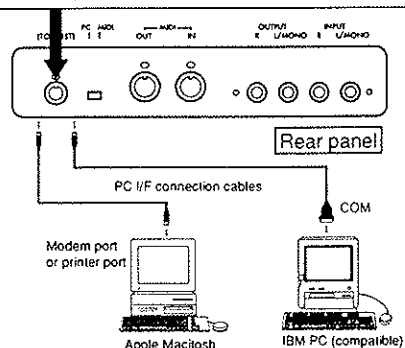

Connection with an IBM PC (compatible) via the AG-001B

1 Use a special PC I/F cable (AG-001B) * sold separately to connect the serial port (COM port) of the IBM PC (compatible) to the PC (TO HOST) connector of the C-350.

If the serial port of your computer uses a 25 pin connector, you will need a 9 pin -25 pin conversion adapter. *sold separately

2 Hold down the [TRANPOSE/MIDI] switch, and press the [VIBES] switch to set the baud rate to "38.4kbps".

If you are using Windows, install the KORG MIDI Driver. For installation, refer to page 24.

Note: You cannot change the baud rate while the PC/MIDI switch is set to the MIDI side. (the baud rate is fixed at 31.25 kbps.) Be sure that the switch is set to the PC side before trying to change the baud rate.

Note: If you set the baud rate to 38.4 kbps but then change the PC/MIDI switch to the MIDI side and turn the power on, the baud rate automatically resets to 31.25 kbps. After returning the switch to the PC side, you will need to change the setting back to 38.4 kbps.

Connection with an Apple Macintosh via the AG-002B

1 Use a special PC I/F cable (AG-002B * sold separately) to connect the modem port or printer port of the Apple Macintosh to the PC (TO HOST) connector of the C-350.

2 Hold down the [TRANPOSE/MIDI] switch, and press the [STRINGS] switch to set the baud rate to "31.25kbps".

If you will be using korg MIDI Driver, refer to page 25.

Note: You cannot change the baud rate while the PC/MIDI switch is set to the MIDI side. (the baud rate is fixed at 31.25 kbps.) Be sure that the switch is set to the PC side before trying to change the baud rate.

[Redacted header text]

[Redacted text]

[Redacted text]

1. Korg MIDI Driver installation and setup

The Korg MIDI Driver software is included with the optional AG-001B and AG-002B. If the application (sequencer) you are using on your IBM PC (compatible) is compatible with Windows, using the Korg MIDI Driver will allow the C-350 connected to the serial port to be handled as a MIDI device. If the application (sequencer) you are using on your Apple Macintosh is compatible with the Apple MIDI Manager, using the Korg MIDI driver will allow the C-350 connected to the serial port to exchange data with the Macintosh.

Installing the Korg MIDI Driver into Windows 95

Note: If the processing speed of your computer is not fast enough, data from MIDI IN may not be received correctly.

1. In the task bar, click the [Start] button. Click the [Control Panel] item located in [Settings].

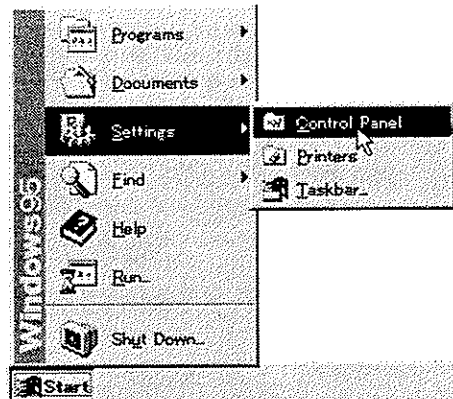

2. In the control panel, double-click the [Hardware] icon, and the hardware wizard will start up. Click the [Next >] button.
3. In reply to the question "Automatically detect new hardware?" be sure to select [No], and click the [Next >] button.

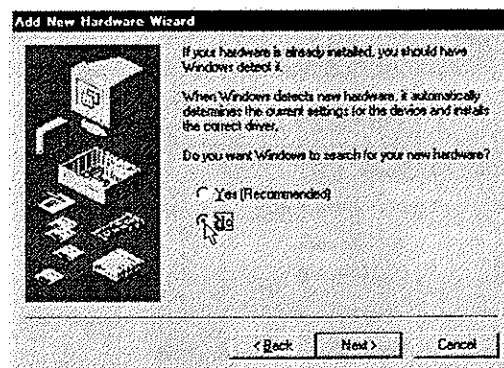

4. Select [Sound, video, and game controllers] and click the [Next >] button.

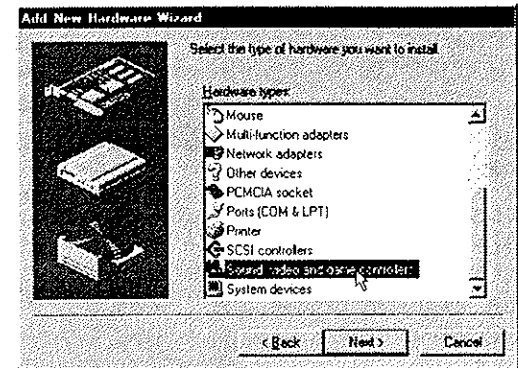

5. Click [Have Disk]. A dialog box will appear, allowing you to specify the drive and directory.

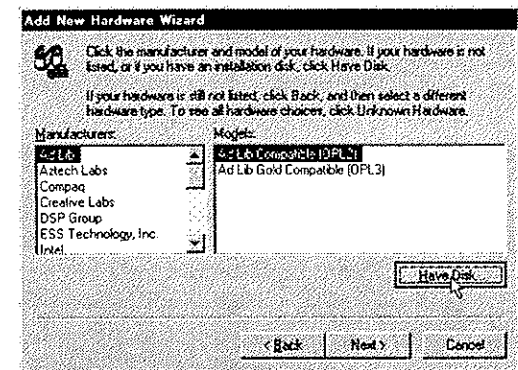

6. Insert the floppy disk included with the AG-001B into the floppy disk drive of your computer. If you have inserted it into drive A, type "A:\\" (or "B:\\" if using drive B), and click the [OK] button.
7. Click the [OK] button and then click [Finish].

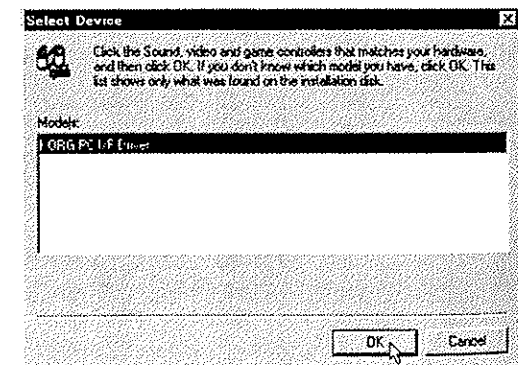

8. Perform the setup following the procedure of "Setting up the Korg MIDI Driver (Windows)" (page 24), and click the [OK] button.

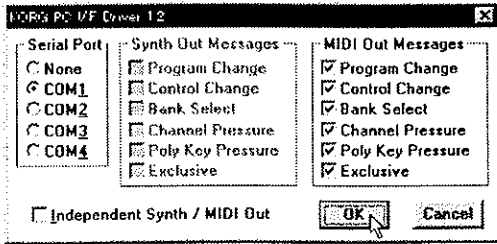

9. Be sure to restart so that the driver will take effect.

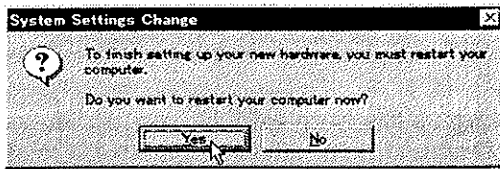

Modifying the Korg MIDI Driver setup for Windows 95

1. In the control panel, double-click the [Multimedia] icon, and the Multimedia Properties dialog box will appear.

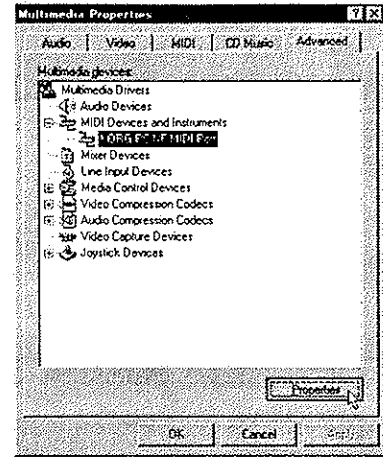

2. Click the [Advanced] tab located in the upper right.
3. Click [+] for [MIDI Device and Instruments] (the display will change to [-]), and click [Korg PC I/F MIDI Port].
4. Click the [Properties] button.
The properties of the Korg PC I/F MIDI Port will appear.
5. Click the [Settings] button.
Follow the procedure of "Setting up the Korg MIDI Driver (Windows)" (page 24), and click the [OK] button.

If you have modified the settings, restart Windows.

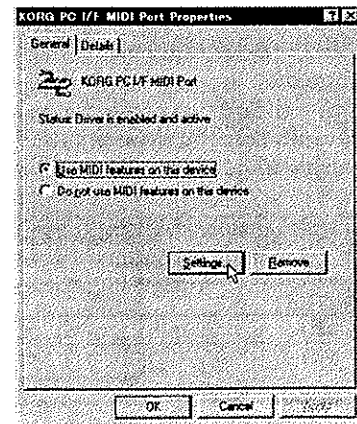

Installing the Korg MIDI Driver into Windows 3.1

Note: If the processing speed of your computer is not fast enough, data from MIDI IN may not be received correctly.

1. In the control panel, double-click the Drivers icon.

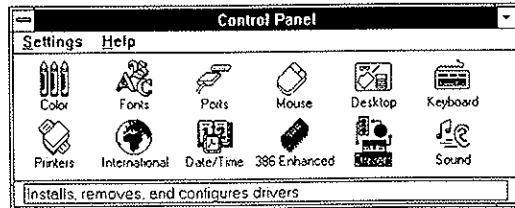

2. Click the [Add] button.

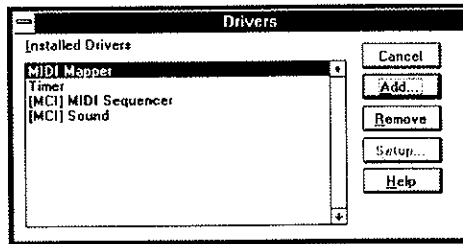

3. From the list of drivers, select [Unlisted or Updated Driver] and click the [OK] button.

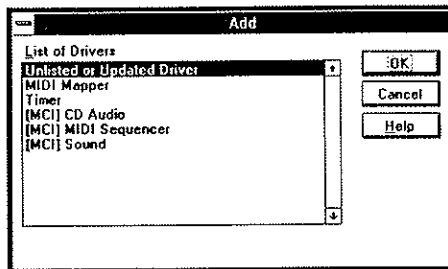

4. Insert the disk included with the AG-001B into the floppy disk drive of your computer. If you insert it into drive A, type in "A:\\" (or "B:\\" if using drive B), and click the [OK] button.

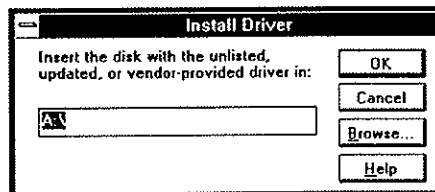

5. Select Korg PC/IF Driver, and click [OK]. The setup window will appear. Now perform the setup as explained in the following section "Setting up the Korg MIDI Driver (Windows)".

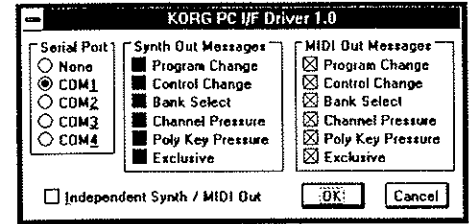

6. After setup, remove the disk and select [Restart Now] to make the driver take effect.

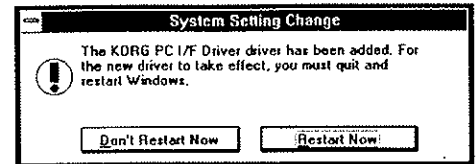

Setting up the Korg MIDI Driver (Windows)

1. Double-click the driver icon located in the control panel, select [Korg PC/IF Driver], and click the set button to access the setup window.

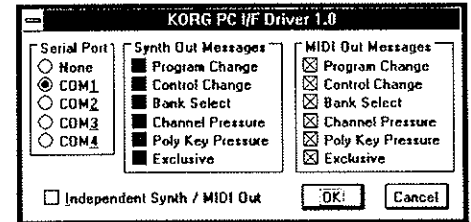

2. Set the Serial Port setting to the serial port that is connected to the C-350 [COM1]~[COM4].

If you wish to use the serial port for another purpose after installing the Korg MIDI Driver, either delete the driver or select [None] to defeat the driver.

3. When the C-350 is connected, [Independent Synth/MIDI Out] is not used, so do not check this item.

If you check it, operation will be incorrect.

4. [MIDI Out Messages] allows you to select the messages that will be transmitted to the C-350.
5. When you have finished making your selections, click the [OK] button. If you wish to cancel, click [Cancel].

Installing the Korg MIDI Driver into the Macintosh

Note: In order to use the Korg MIDI Driver, Apple MIDI Manager and PatchBay must already be installed. Use the Apple MIDI Manager and PatchBay that are included with the MIDI application that you are using. They are not included with the AG-002B.

When the Korg MIDI Driver is used, the "Modem MIDI Out/Port settings" dialog box allows you to specify the MIDI channels and types of messages that will be sent to the C-350. If you do not require this function, you can simply use the Apple MIDI Driver without using the Korg MIDI Driver. When using the Apple MIDI Driver or when using a MIDI application (sequencer) which does not use the Apple MIDI Driver, refer to page 26.

1. Copy the Korg MIDI Driver from the disk included with the AG-002B into the system folder of the start-up drive.

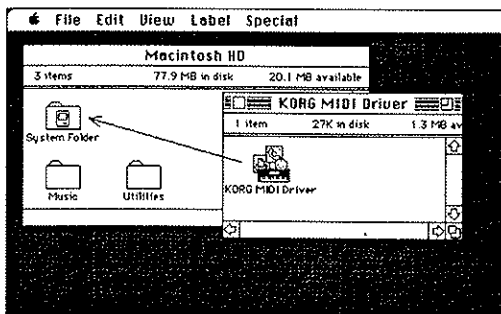

2. If the system folder contains the Apple MIDI Driver, either delete it or move it to another folder. Be careful not to delete or move the Apple MIDI Manager.

* The Korg MIDI Driver includes the functions of the Apple MIDI Driver.

3. From the Special menu, choose "Restart".

Setting up the Korg MIDI Driver (Macintosh)

1. Start up PatchBay.

If installation has been performed correctly, the Korg MIDI Driver icon will appear in the PatchBay window when PatchBay is started up, as shown below. (The Modem/Printer port displays may be different, depending on your setup.)

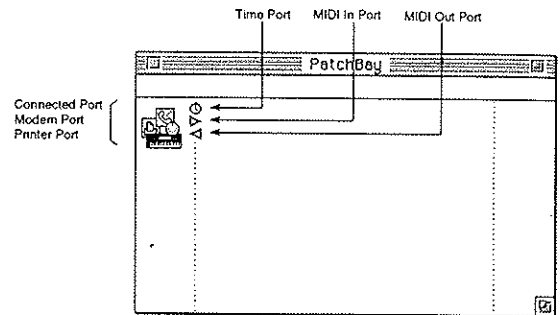

2. In PatchBay, double-click the Korg MIDI Driver icon.

A setup dialog box will appear.

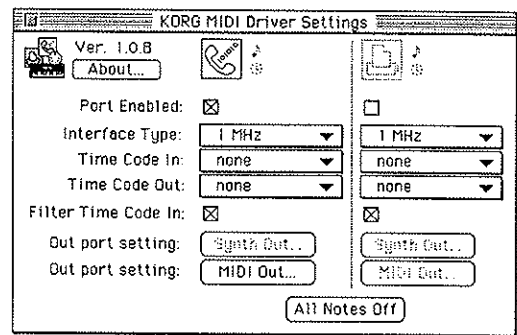

3. Check Port Enabled for the port to which the C-350 is connected, and select [1 MHz] as the Interface Type.

(Since the C-350 does not contain a Korg PC IF, do not select [Korg PC IF].)

4. Click the [Out Port Setting] button.

The following dialog box will appear. Here you can select the MIDI channels/messages that will be output to each port. Only the channels/messages which are checked will be output.

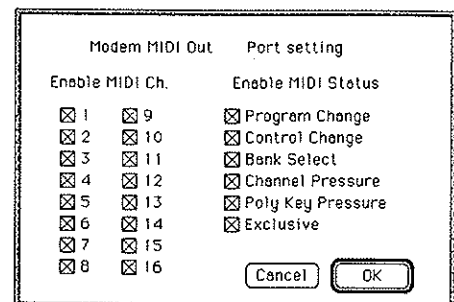

5. After making settings, click the [OK] button.
6. Start up your MIDI application (sequencer), and drag with the mouse from the Out Port ◀ symbol of the MIDI application to connect it to the MIDI Out of the MIDI Driver.
 - For details on using PatchBay, refer to the explanation contained in "About PatchBay..." in the "Ⓜ" menu.

If you wish to use the Apple MIDI Driver, start up PatchBay (after first deleting or moving the Korg MIDI Driver if it is in the system folder), double-click the Apple MIDI Driver icon, check Enabled for the port to which the C-350 is connected, set the Interface Type to [1 MHz], and close the dialog box. In the PatchBay, drag with the mouse from the Out Port ◀ symbol of the MIDI application (sequencer) to connect it to MIDI Out.

If you are using a MIDI application (sequencer) which does not use the Apple MIDI Manager, select the Port to which the C-350 is connected, and set the Clock setting to [1 MHz].

About the MIDI File Translator included with the AG-002

Most commercially available Standard MIDI File (SMF) song files are saved in MS-DOS format. The MIDI File Translator included with the AG-002B is a translator program for Apple File Exchange that converts MS-DOS SMF song files into a form that Macintosh MIDI applications can recognize as SMF files.

1. Put the MIDI File Translator into the Apple File Exchange folder.



2. Double-click Apple File Exchange to start it up.
3. Insert the MS-DOS disk that you wish to convert into the floppy disk drive.

A window such as the following will appear. Be sure to start up Apple File Exchange before inserting the MS-DOS format disk into the disk drive.

4. Select the song that you wish to convert.
5. Click the "<<Convert<<" (or ">>Convert>>") button.

The conversion will begin. When the bar graph reaches 100% the conversion is complete. The converted file will appear in the box at the left.

6. Exit Apple File Exchange.

Using PC Exchange to convert SMF data

If Apple File Exchange is not included with your Macintosh system, you can use PC Exchange to convert MS-DOS format SMF song files so that they can be recognized by the Macintosh.

1. In the control panel, open PC Exchange.
The PC Exchange control panel will appear.
2. Click the [Add...] button.
The [Specify application for DOS extension] window will appear.
3. Input "MID" for the DOS extension item.
MS-DOS uses a filename extension consisting of a period and three characters to distinguish different types of files. It is usual to assign an extension of ".MID" to SMF files.
4. From the list that appears in the lower part of the dialog box, select a MIDI application (sequencer) that can use SMF data.
The icon selected for the application item will appear.
Now select a MIDI application (sequencer) that can use SMF data, and that software will be able to open SMF song files.
5. From the [Document type] popup menu choose [MIDI] and click the [OK] button.

The item added to the PC Exchange window will be displayed, and has been registered.

Now you can insert an MS-DOS SMF disk into the disk drive and use it as is.

* For details refer to the explanation of "Macintosh PC Exchange."



2. Assembling the Stand

Use the following procedure to assemble your ST-350 or ST-150. The assembly procedure for both models is the same; the only external difference is the number of pedals. The illustrations below are based on the appearance of the ST-350 (three pedals).

Caution

Two or more people are required to assemble the piano unit.

When attaching the piano to the stand, be careful not to let go of it.

Make sure you do not mistaken the type or direction of each part. Follow the assembly procedures carefully during assembly.

If too much force is applied to the front before fastening it with the mounting screws, the piano could fall off the stand.



1. You will need a Phillips head screw driver to tighten the screws.



2. Open the box and take out the parts. Make sure all the parts shown below are included in the box.

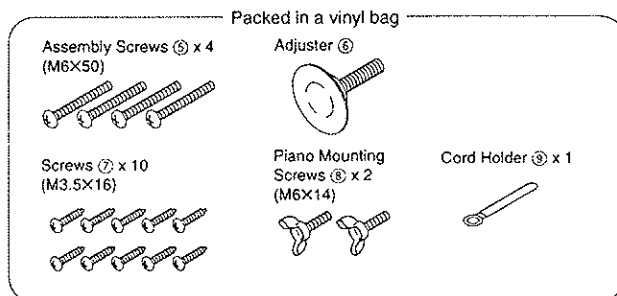
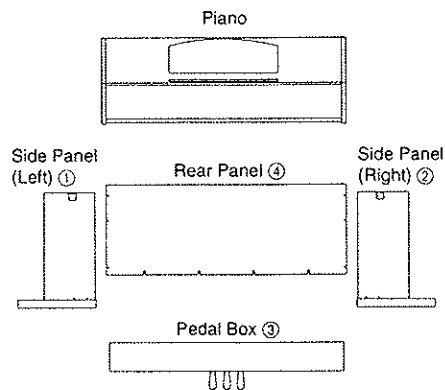

3. For assembly, you must place the back of the stand on a smooth surface such as the floor, as shown in the diagram below. Assemble the Side Panel (Left) ① and the Side Panel (Right) ② to the Pedal Box ③ using the 4 assembly screws ⑤.

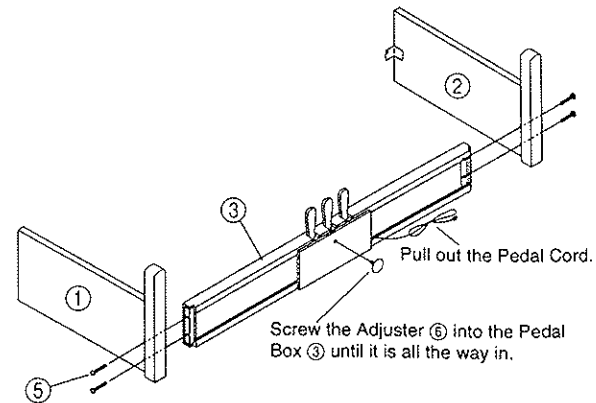

4. Attach 3 Screws ⑦ in the Pedal Box ③ as shown, partially tightening them.

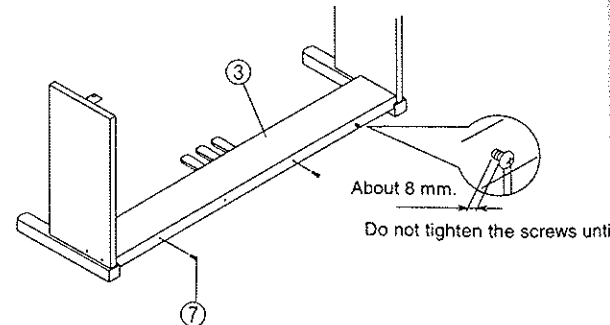

5. Assemble the Rear Panel ④. Tighten the Screws ⑦ from the previous step into the bottom of the Rear Panel ④. Fasten the Side Panels to the Rear Panel ④ using the 6 Screws ⑦. Use the last 1 remaining Screw to attach the Cord Holder ⑨.

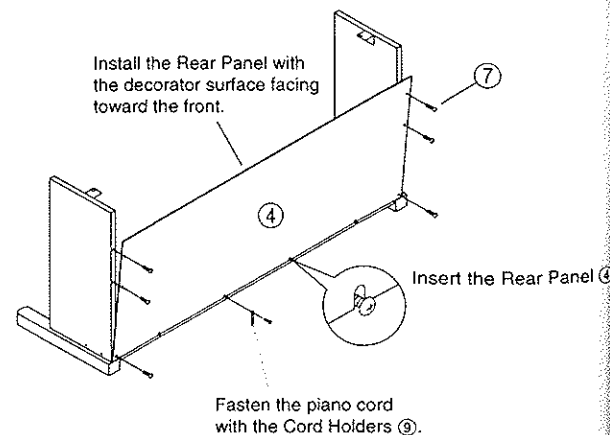

6. Attach the Piano.
Rest the piano on the rear of the side panel tops, lift it up slightly and slide it toward the front of the side panels.

The rubber feet on the bottom of the piano will make contact with the brackets on the side panels and cause it to stop.

Fasten the two piano mounting screws (8) to the bottom of the piano.

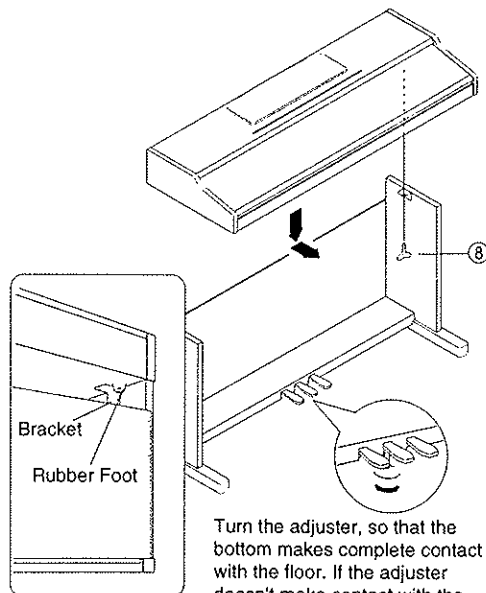

Turn the adjuster, so that the bottom makes complete contact with the floor. If the adjuster doesn't make contact with the floor, the Pedals will be unstable and the sound may be affected.

7. Connect the pedal cord and fasten it in place.

The top of the rear panel is open to improve the acoustics.

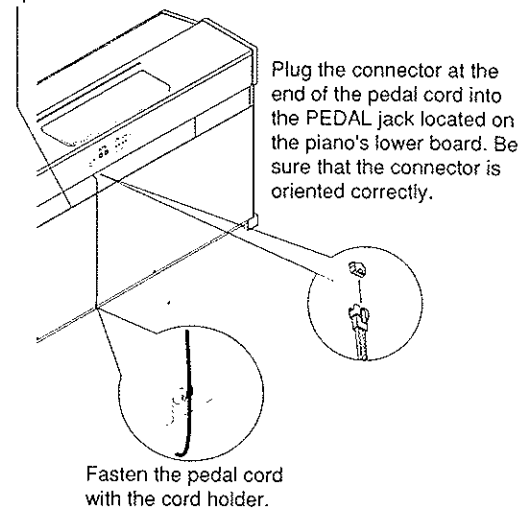

Plug the connector at the end of the pedal cord into the PEDAL jack located on the piano's lower board. Be sure that the connector is oriented correctly.

Fasten the pedal cord with the cord holder.

Post-assembly Check

- Are there any parts left over?
If there are any parts remaining, check each of the part positions shown in the illustration to find where they are missing from.
- Check the mounting screws for any looseness.



Caution

Cautions when Moving

Please disconnect the piano from the stand and move them separately. After moving, reconnect according to these instructions. Also, be careful of the following points when moving the piano.

- Wind up the power cord in a small bundle. If it is left to dangle, the cord could catch on some other object and be cut, and could cause short circuits or other damage.
- Be careful that the pedal cord doesn't catch on a door knob or other object during moving.

Loose Screws After

If period of time passes after assembly, the screws holding the parts of the stand together may become loose, causing the stand to wobble. If this happens, re-tighten each screw.

Disassembly

To disassemble the piano and the stand assembly, follow the assembly procedure in reverse order. After disassembly, keep the screws and other parts so that they do not get lost.

To disconnect the pedal cord, pull on the cord connector while pressing the little tab (1) on the connector. Do not exert too much force on the cord, since it could break.

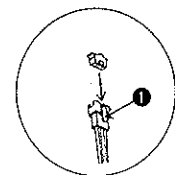

3. MIDI Implementation Chart

[Digital piano]
C-350/C-150

MIDI Implementation Chart

Function		Transmitting	Receiving	Remarks
Basic channel	Default	1		
	Changed	1-16	1-16	
Mode	Default	X	3	
	Message Altered	X *****	X	
Note number	True Voice	15-113 *****	0-127 21-108	
		Velocity	Note ON Note OFF	1-127 X
Aftertouch	Key's	X	X	
	Ch's	X	X	
Pitch bender		X	X	
Control change				
	64	O	O	Damper pedal *1
	66	O	O	Sostenuto pedal *1
	67	O	O	Soft pedal *1
Prog change		0-20	0-20	
	True#	*****	0-20	
Exclusive		O	O	Device Inquiry Sequence Data Dump
Common	:Song position	X	X	
	:Song select	X	X	
	:Tune	X	X	
Realtime	:Clock	O	X	
	:Commands	O	X	
Aux message	:Local ON/OFF	X	O	
	:All notes OFF	O	O123-127	
	:Active sensing	O	O	
	:Reset	X	X	
Remarks	*1 Receive if CONTROL CHAGE is enabled. *2 Transmit/receive if CONTROL CHANGE is enabled.			

Mode 1: OMNI ON, POLY

Mode 2: OMNI ON, MONO

O: Yes

32 Mode 3: OMNI OFF, POLY

Mode 4: OMNI OFF, MONO

X: No

* Consult your local Korg distributor for more information on MIDI Implementation.

4. Trouble Shooting

If the following problems develop during normal operation of the instrument, follow the suggestions below and check the unit to identify and correct the problem. If the instrument still does not function properly, consult your dealer or a KORG service center.

Power does not turn on

- Is the power cable connected to an AC outlet?
- Is the power switch on?

If the problem is still not resolved, contact a Korg dealer.

No sound

- Is the [MASTER VOLUME] slider of the C-350/150 raised?
- Is the headphone jack in use?
- Make sure that the Local setting is ON.

Sound does not change

- Turn off the [DEMO] switch.

Sound is interrupted

- The sounds of the C-350/C-150 are produced by samples (recordings) of original instrumental sounds. For some sounds, pressing a note will play one sample, and for other sounds, two samples. The [PIANO] sound use two samples. When this sound is selected, the maximum number of notes which can be played simultaneously will be 16, including notes held by the damper pedal. For other sounds, the maximum number of simultaneous notes will be 32. If you are using a Layer to play two sounds simultaneously, the maximum number of simultaneous notes will depend on whether the sounds use one or two samples. For example, the maximum number of simultaneous notes is 10 if you are playing the PIANO voice in combination with some other voice.

The pitch or tone of a piano sound appears incorrect in a particular range.

- The piano sounds on this instrument have been created with the intent of reproducing the actual sounds of a piano as faithfully as possible.
- This means that in some pitch ranges, it may sound as though overtones are emphasized differently, or that a certain pitch or range sounds incorrect, but this is not a malfunction.

Pedal does not work correctly

- Has the pedal connector been disconnected?

Sostenuto pedal effect does not work

- Has the pedal connector been disconnected?
- If model C-150: Check the pedal setting.

Cannot record

- Is there sufficient free space in the recorder?

Does not respond to transmitted MIDI data

- Make sure that all MIDI cables are connected correctly.
- Make sure that the C-350/150 is receiving data on the same channel as the transmitting device is using.

5. Specification

Keyboard	88 keys (A0—C8)
Voices	Six voices: Piano, Electric piano Harpsichord, Vibraphone, Organ Strings
Polyphony	32/16*
Effect (C-350 only)	Brilliance, Reverb, Chorus
Recorder	Maximum 4,000 notes: Tempo, Metronome, Record, Start/Stop, Repeat
Keyboard modes	Single, Layer
Controls	Volume, Power, TRANSPOSE/FUNCTION, TOUCH, VOICE SELECTOR, TEMPO, METRONOME DEMO, PC/MIDI (C-350 only)
Pedal controls	C-350: Damper, Soft, Sostenuto C-150: Damper, Soft/Sostenuto
Connections	Headphones (x2), INPUT (L/MONO R), OUTPUT (L/MONO, R), MIDI (IN OUT), PC (TO HOST [C-350 only])
Main amplifier	20W x 2
Speakers	16cm x 2
Power supply	AC, Local Voltage
Power consumption	65W
Dimensions	C-350: 1379(W) x 445(D) x 849(H)mm C-150: 1359(W) x 443(D) x 804(H)mm
Weight (with stand)	C-350: 45.9kg, C-150: 39.7kg
Option	C-350: AG-001B, AG-002B(Connection kit) C-150: _____

*May decrease depending on sounds or layers.

Specifications and finish are subject to change without notice for purpose of product enhancement.

- Apple Macintosh, MIDI Manager, MIDI Driver, and PatchBay are registered trademarks and trademarks of Apple Computer Corporation, USA.
- IBM is a registered trademark of IBM Corporation, USA.
- MIDI Player is a registered trademark of Passport Designs Corporation.
- MS-DOS and Windows are registered trademarks and trademarks of Microsoft Corporation, USA.

6. Index

A

accent sound 13

B

Backup Battery 3

baud rate 22

Brilliance 10

C

Chorus Effect 11

Connections 18

 MIDI device 18

 computer 22

CONTROL CHANGE 20

D

damper pedal 11

Data Dump 21

demo songs 9

E

effects 10

 Brilliance 10

 Chorus Effect 11

 Reverb Effect 11

H

headphones 8

K

key cover 8

keyboard response 13

Korg MIDI Driver 24

 Macintosh 27

 Windows 3.1 26

 Windows 95 24

L

LAYER 10

LOCAL ON/OFF 19

M

Macintosh 27

Master Volume 8

METRONOME 12

 accent sound 13

 Pattern Selector 13

 TEMPO 12

 relative volume 12

Memory 17

MIDI 18

MIDI channel 19

MIDI File Translator 28

Multivoice 20

Music Stand 8

P

Pattern Selector 13

pedals 11

 damper pedal 11

 soft pedal 11

 sostenuto pedal 11

 soft/sostenuto pedal 11

PC Exchange 28

Playing Back 16

power 8

PROGRAM CHANGE 19

R

Recording 16

 Memory 17

 Playing Back 16

 Repeating Playback 17

Reverb Effect 11

S

SINGLE 10

soft pedal 11

sostenuto pedal 11

soft/sostenuto pedal 11

stretch tuning 15

synchronizing 20

T

Temperaments 15

TEMPO 12

Touch Control 13

transpose 14

Tune 15

V

Voice Modes 10

 LAYER 10

 SINGLE 10

 relative volume 10

W

Windows 3.1 26

Windows 95 24

7. MIDI/TRANPOSE Switch

7. MIDI/TRANPOSE Switch

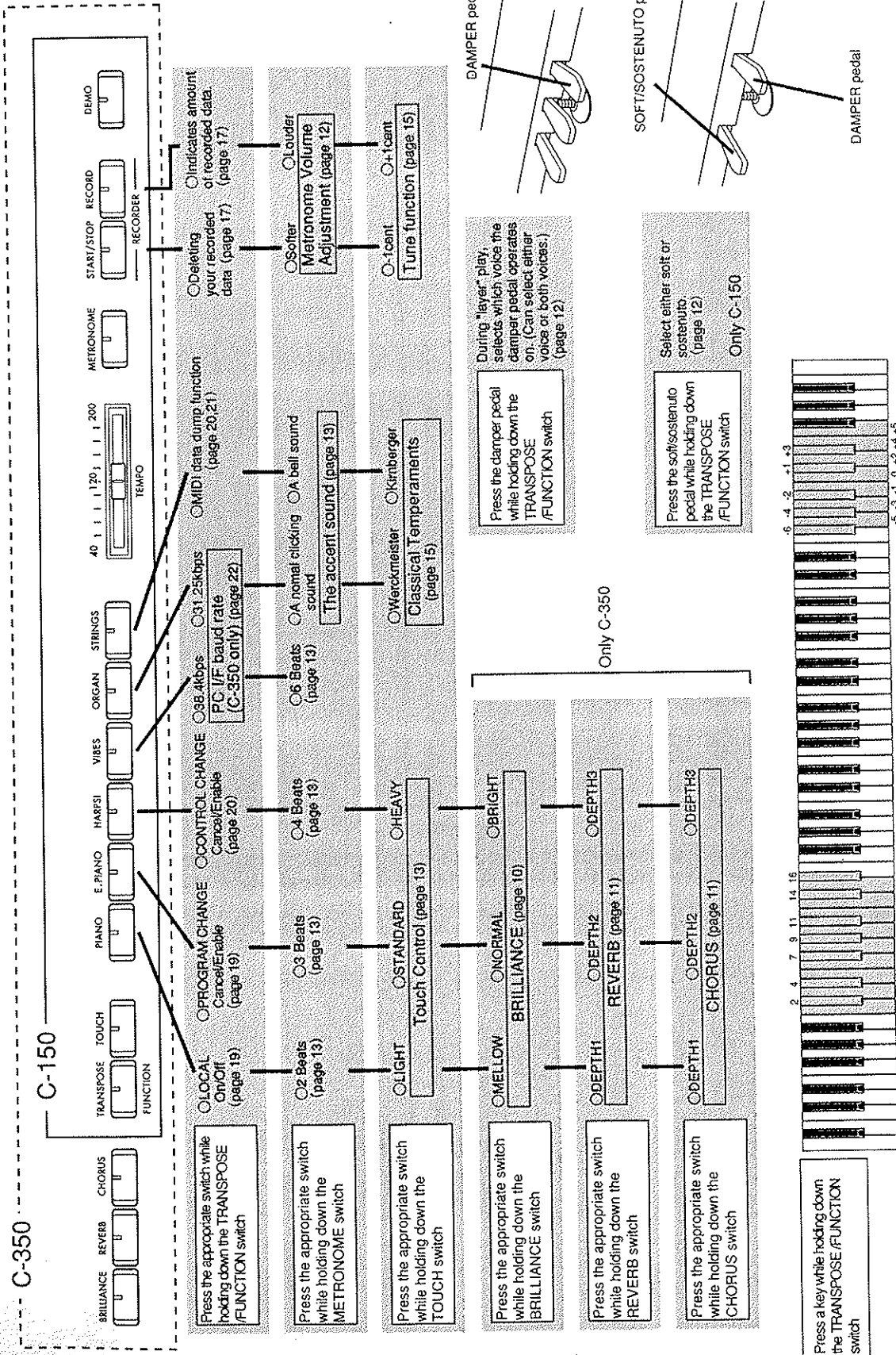

NOTICE

KORG products are manufactured under strict specifications and voltages required by each country. These products are warranted by the KORG distributor only in each country. Any KORG product not sold with a warranty card or carrying a serial number disqualifies the product sold from the manufacturer's/distributor's warranty and liability. This requirement is for your own protection and safety.

DESC: OWNERS MANUAL C150/C

QTY: 0001 SN:

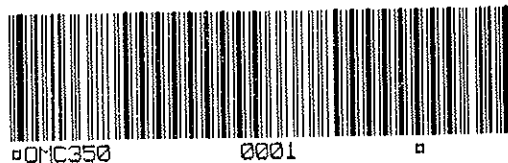

KORG KORG INC.

15 - 12, Shimotakaido 1 - chome, Suginami-ku, Tokyo, Japan.